

Multilingual Version

[English](#)

[中文](#)

NETWORK CAMERA SERIES

OPERATION GUIDE

Please read instructions thoroughly before operation and retain it for future reference.

IMPORTANT SAFEGUARD



All lead-free products offered by the company comply with the requirements of the European law on the Restriction of Hazardous Substances (RoHS) directive, which means our manufacture processes and products are strictly "lead-free" and without the hazardous substances cited in the directive.



The crossed-out wheeled bin mark symbolizes that within the European Union the product must be collected separately at the product end-of-life. This applies to your product and any peripherals marked with this symbol. Do not dispose of these products as unsorted municipal waste. Contact your local dealer for procedures for recycling this equipment.



This apparatus is manufactured to comply with the radio interference requirements.

Federal Communications Commission Interference Statement

This equipment has been tested and found to comply with the limits for a Class B digital service, pursuant to Part 15 of the FCC rules. These limits are designed to provide reasonable protection against harmful interference in a residential installation.

Any changes or modifications made to this equipment may void the user's authority to operate this equipment. This equipment generates, uses, and can radiate radio frequency energy. If not installed and used in accordance with the instructions, may cause harmful interference to radio communications. However, there is no guarantee that interference will not occur in a particular installation. If this equipment does cause harmful interference to radio or television reception, which can be determined by turning the equipment off and on, the user is encouraged to try to correct the interference by one or more of the following measures:

- Reorient or relocate the receiving antenna.
- Increase the separation between the equipment and receiver.
- Connect the equipment into an outlet on a circuit different from that to which the receiver is connected.
- Consult the dealer or an experienced radio/TV technician for help.
- FCC Caution: Any changes or modifications not expressly approved by the party responsible for compliance could void the user's authority to operate this equipment.
- All external cables connecting to this basic unit must be shielded.
For cables connecting to PCMCIA cards, see the option manual or installation instructions.

This device complies with Part 15 of the FCC Rules. Operation is subject to the following two conditions:

- (1) This device must not cause harmful interference, and
- (2) This device must accept any interference received, including interference that may cause undesired operation.

Trademark Acknowledgements

iPad® & iPhone® are the registered trademarks of Apple Inc.

Android™ is a trademark of Google Inc. Use of this trademark is subject to Google Permissions.

Microsoft®, Windows® & Internet Explorer® are registered trademarks of Microsoft Corporation in the United States and/or other countries.

Disclaimer

We reserve the right to revise or remove any content in this manual at any time. We do not warrant or assume any legal liability or responsibility for the accuracy, completeness, or usefulness of this manual. The content of this manual is subject to change without notice.

This product doesn't have a standby / shutdown mode.

MPEG4 Licensing

THIS PRODUCT IS LICENSED UNDER THE MPEG4 VISUAL PATENT PORTFOLIO LICENSE FOR THE PERSONAL AND NON-COMMERCIAL USE OF A CONSUMER FOR (i) ENCODING VIDEO IN COMPLIANCE WITH THE MPEG4 VISUAL STANDARD ("MPEG-4 VIDEO") AND/OR (ii) DECODING MPEG4 VIDEO THAT WAS ENCODED BY A CONSUMER ENGAGED IN A PERSONAL AND NON-COMMERCIAL ACTIVITY AND/OR WAS OBTAINED FROM A VIDEO PROVIDER LICENSED BY MPEG LA TO PROVIDE MPEG4 VIDEO. NO LICENSE IS GRANTED OR SHALL BE IMPLIED FOR ANY OTHER USE. ADDITIONAL INFORMATION INCLUDING THAT RELATING TO PROMOTIONAL INTERNAL AND COMMERCIAL USES AND LICENSING MAY BE OBTAINED FROM MPEG LA, LLC. SEE [HTTP://WWW.MPEGLA.COM](http://www.mpegla.com).

GPL Licensing



This product contains codes which are developed by Third-Party-Companies and which are subject to the GNU General Public License ("GPL") or the GNU Lesser Public License ("LGPL").

The GPL Code used in this product is released without warranty and is subject to the copyright of the corresponding author.

Further source codes which are subject to the GPL-licenses are available upon request.

We are pleased to provide our modifications to the Linux Kernel, as well as a few new commands, and some tools to get you into the code. The codes are provided on the FTP site, and please download them from the following site or you can refer to your distributor:

<http://download.dvrtw.com.tw/GPL/IPCAM/F-Series/linux.tar.gz>

TABLE OF CONTENTS

1. OVERVIEW.....	1
1.1 Product Features.....	1
1.2 Package Content.....	1
1.3 Product Overview.....	1
1.4 Rear Panel.....	1
1.5 External I/O Port.....	2
1.6 Status Indicator.....	2
1.7 DC12V Adapter Specifications (For DC12V models only).....	2
1.8 Insert a Micro SD Card (Selected Models Only).....	3
2. CAMERA ACCESS WITH INTERNET EXPLORER.....	4
2.1 Camera Login.....	4
2.2 Control Panel Overview.....	4
2.3 Digital PTZ (DPTZ) Operations.....	6
2.4 Event Record Search & Playback.....	6
3. CAMERA CONFIGURATIONS.....	8
3.1 System configuration menu.....	8
3.2 Network.....	9
3.2.1 Network.....	9
3.2.2 QoS.....	9
3.2.3 DDNS.....	9
3.2.4 SNTP.....	10
3.2.5 FTP.....	10
3.2.6 MAIL.....	10
3.2.7 Filter.....	11
3.2.8 UPnP / Bonjour.....	11
3.3 Camera.....	12
3.3.1 Camera.....	12
3.3.2 Video.....	13
3.3.3 Color.....	13
3.3.4 Audio.....	13
3.3.5 Advanced.....	14
3.4 Record.....	14
3.4.1 Record.....	14
3.4.2 Record Timer.....	15
3.5 Storage.....	15
3.5.1 Memory.....	15
3.6 Trigger.....	15
3.6.1 Trigger.....	15
3.7 General.....	17
3.7.1 General.....	17
3.7.2 Time.....	17
3.7.3 Server Log.....	18
3.7.4 Online.....	18
3.7.5 Account.....	19
3.7.6 Maintenance.....	19
APPENDIX 1 PRODUCT SPECIFICATIONS.....	21
APPENDIX 2 BIT RATE TABLE FOR REFERENCE.....	22
APPENDIX 3 Q&A.....	24
APPENDIX 4 RECORDING TIME TABLE.....	25
APPENDIX 5 MICRO SD CARD COMPATIBLE LIST.....	26

1. OVERVIEW

1.1 Product Features

- Easy **network setup** with your **iPhone / iPad**
- **1.3 Megapixel** H.R. sensor with **HDTV 720p** quality, allowing users to notice minor details more easily
- **External alarm I/O device** connection
- Microphone built-in for **audio recording**
- **Remote Surveillance**
 - Fully compatibility on iOS® devices, and Internet Explorer® on Windows® operating system
- **(Optional) Micro SD card** support for video recording

1.2 Package Content

- | | | |
|---|---|---|
| <input type="checkbox"/> Network camera | <input type="checkbox"/> Camera Bracket | <input type="checkbox"/> 4-pin Terminal |
| <input type="checkbox"/> Quick Setup with iPhone / iPad | <input type="checkbox"/> Adapter (DC5V models only) | |

1.3 Product Overview

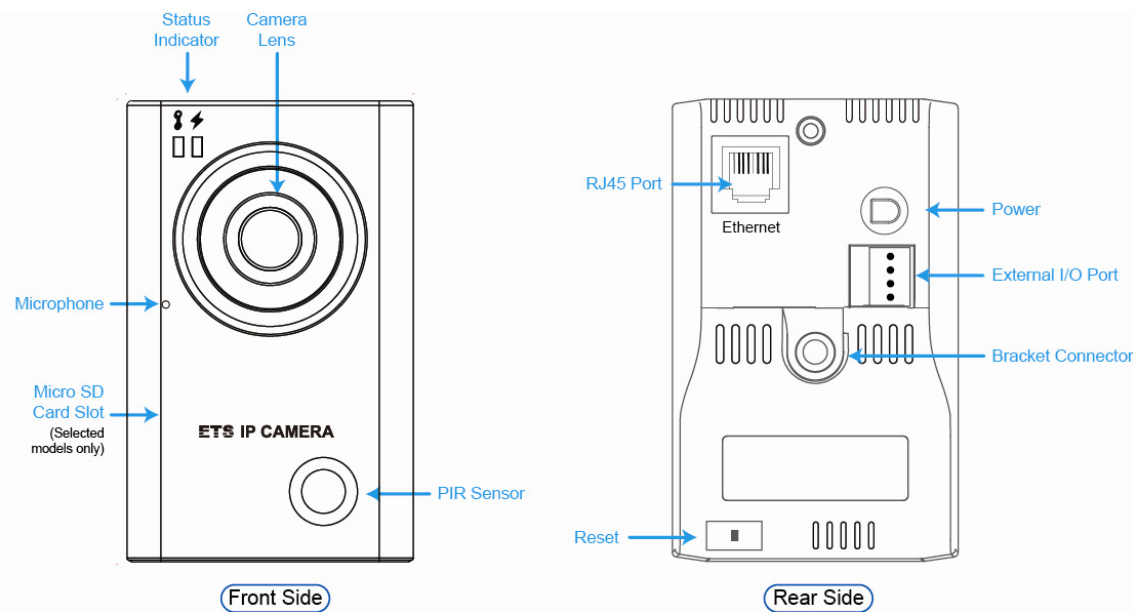

1.4 Rear Panel

RJ45 Port:	Connect your network cable.
Power:	Connect the supplied regulated power supply.
Reset:	With the power connected, press to reset all parameters, including the IP address to factory default settings. The camera will reboot after default reset. Please do not disconnect your camera during the reset process.
External I/O Port	A 4-pin I/O terminal is supplied with the camera for external alarm device connection. For details, please refer to "1.5 External I/O Port" at page 2.



1.5 External I/O Port

This camera supports external I/O device connection, and a 4-pin I/O terminal is supplied with this camera for easy connection.

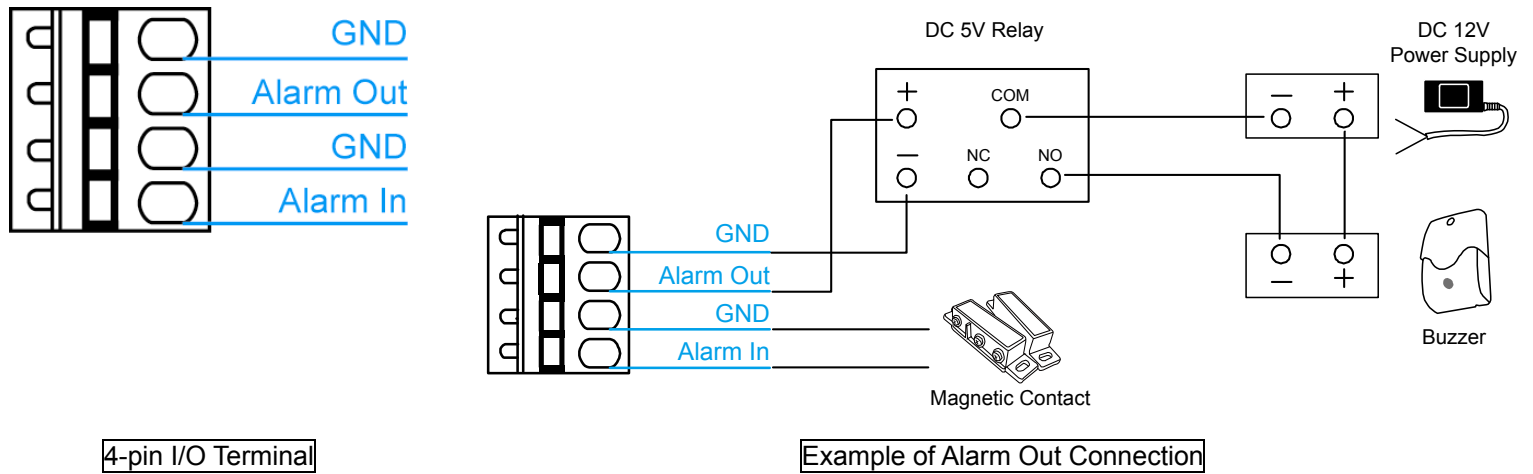
Below shows which input on the I/O terminal you should use for wiring when you want to connect an external device to this camera.



1.6 Status Indicator

ICON	 LAN connection status	 Internet connection status
System Status		
During powering on	Always on	Always on
Reset default	Blinking (on 250 ms, off 250 ms) ●○○●○○●○○●○○	Always off
Upgrade	Blinking (on 250 ms, off 250 ms) ●○○●○○●○○●○○	Blinking (on 250 ms, off 250 ms) ●○○●○○●○○●○○
Connection Status		
LAN connected	Always on	--
LAN disconnected	Blinking (on 100 ms, off 500 ms) ●○○●○○●○○●○○	--
Internet connected	--	Always on
Internet disconnected	--	Blinking (on 100 ms, off 500 ms) ●○○●○○●○○●○○
3G Connection Error on iPhone / iPad / Android Mobile Device		
3G Connection Setting Uncompleted	--	Blinking (on 5 sec, off 0.5 sec, on 0.5 sec, off 0.5 sec, on 5 sec) ●●●●○○●●●●

* LED blinking frequency - ●LED on / ○LED off

1.7 DC12V Adapter Specifications (For DC12V models only)

Note: Adapters are not supplied with the package for DC12V models. Please purchase separately.

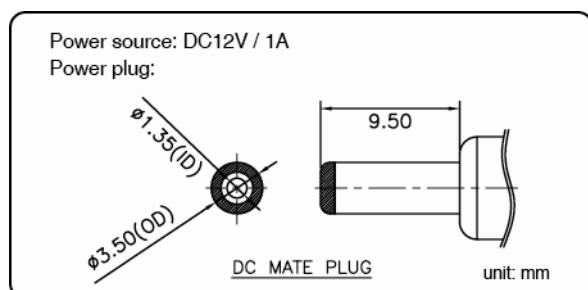

1.8 Insert a Micro SD Card (Selected Models Only)

For local video recording, a micro SD card slot can be found on the side of the camera.

Note: Before inserting a micro SD card, make sure you've copied all important data saved in the card (if any) to other storage media, or the data will be removed after inserting it to the camera.

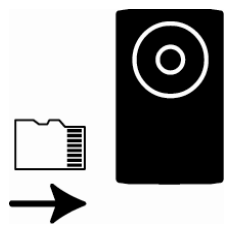

Card slot on the left

Check the indication above to ensure where your micro SD card is, and insert it to your camera.

Note: It's recommended to insert or remove the micro SD card with power disconnected, or the camera will reboot.

Note: For the compatible list of the micro SD card, please refer to "APPENDIX 5 MICRO SD CARD COMPATIBLE LIST" at page 26.

2. CAMERA ACCESS WITH INTERNET EXPLORER

This network camera can be accessed via Microsoft® Internet Explorer® and iPhone / iPad / Android mobile devices with our self-developed program “EagleEyes” installed depending on different using situations.

Note: For details about accessing network cameras via iPhone / iPad / Android mobile devices, please refer to <http://www.eagleeyesccv.com>.

Before using the camera, make sure you have configured the network settings, and the network connection is fine.

For network configurations, please refer to:

- **“Quick Setup With iPhone / iPad”** supplied with your camera if you’re using iPhone / iPad, and your network environment is wireless.
- **“ADVANCED NETWORK SETUP”** downloadable from www.surveillance-download.com/user/m301.swf if your network environment is not wireless.

2.1 Camera Login

Step1: Open your web browser, and key in <http://ipaddress:portnum> in the URL address box.

For example, for the IP address 60.121.46.236 and port No. 888, please key in “<http://60.121.46.236:888>” into the URL address box, and press “Enter”.

Step2: In the login page, key in the user name and password, and enter the security code from the image below if any. Then, click “LOGIN”.

Step3: The wizard is then started.

- To skip the wizard and directly access the camera live view, click “Close”.
- To directly access the camera live view without starting the wizard for the login next time, check “Do not start wizard at login”.









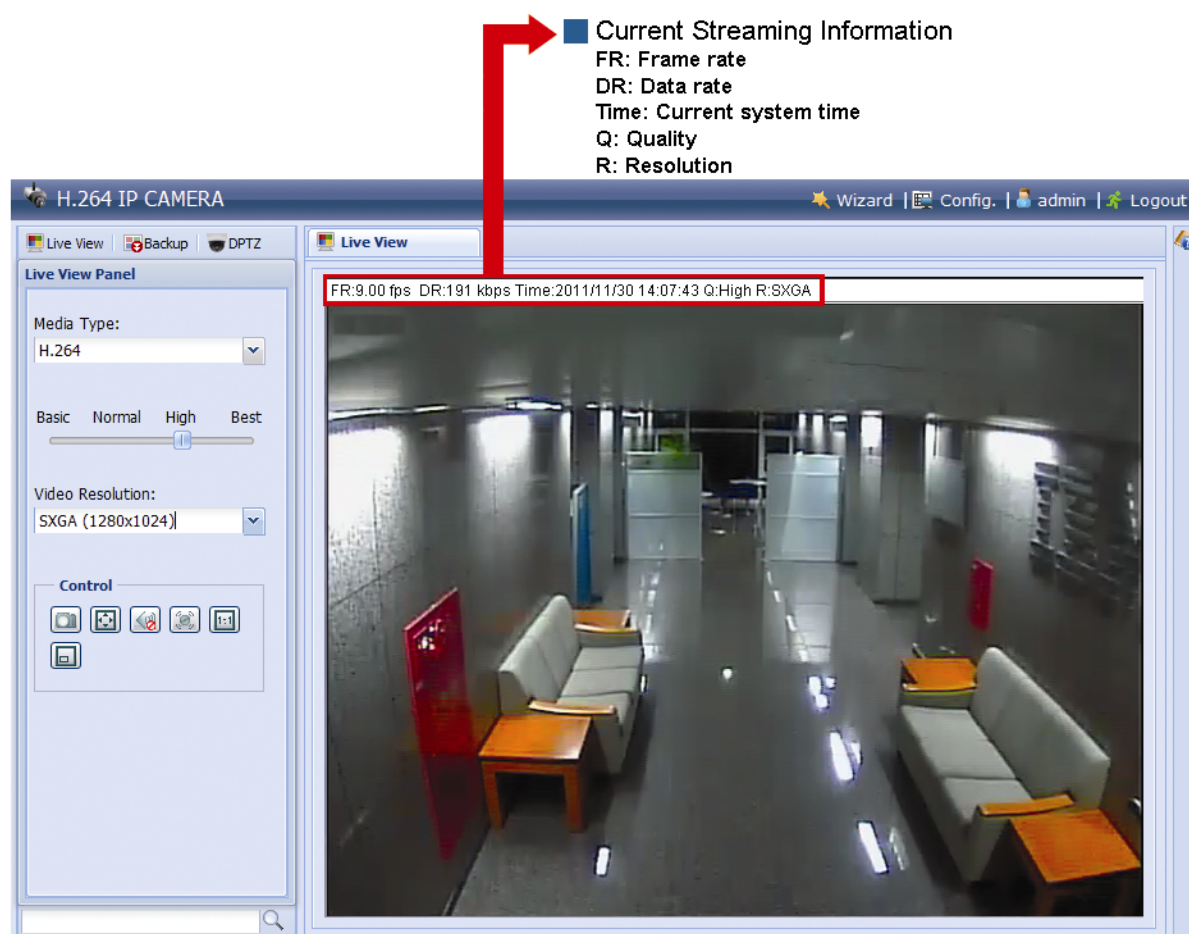



Note: If you’re prompted to install “VLC player”, “Software” or “H264 Streaming Viewer”, please agree to proceed the installation. Or, you might not be able to see the live view properly.

Step5: When the login is successful, the live view is shown.

2.2 Control Panel Overview

Note: The buttons available depend on the user level used to log in.



Function	Icon	User Level	Description
Live		Supervisor / Power User / Normal User / Guest	Switch to the live view page.
DPTZ		Supervisor / Power User / Normal User	Switch to the DPTZ configuration page. For details, please refer to "2.3 Digital PTZ (DPTZ) Operations" at page 6.
Backup		Supervisor / Power User	Enter the event record list for video playback. For details, please refer to "2.4 Event Record Search & Playback" at page 6.
Config.		Supervisor	Switch to the system configuration page, and the functions available for "Supervisor" and "Power User" are different. For details, please refer to "3.1 System configuration menu" at page 8.
Media Type	--	Supervisor / Power User / Normal User / Guest	Select the image player from the drop-down list: <ul style="list-style-type: none"> ■ H.264 / MPEG-4 / Motion JPEG ■ QuickTime <p>QuickTime is Apple Inc.'s multimedia software. You need to have QuickTime installed in your operating system before selecting "QuickTime". When it is selected, you will be promoted to enter the user name and password to access the camera.</p> <ul style="list-style-type: none"> ■ VLC
Quality	--	Supervisor / Power User / Normal User	Click & drag the slider to select the video quality: Basic / Normal / High / Best.
Video Resolution	--	Supervisor / Power User / Normal User	Select the image resolution from the drop list: <ul style="list-style-type: none"> <li style="width: 50%;">■ SXGA (1280 x 1024) <li style="width: 50%;">■ HD720P (1280 x 720) <li style="width: 50%;">■ QVGA (320 x 240) <li style="width: 50%;">■ VGA (640 x 480)
Live View Size:		Supervisor / Power User / Normal User	
Normal Size			The current live view size is the same as the selected resolution.
Fit to screen			The selected resolution is resized to fit into the current live view size. <i>This icon doesn't work when the selected resolution is VGA or QVGA.</i>
Scale			Click and hold the movable square on the left bottom corner of the live view to move <i>This icon appears only when the selected resolution is larger than the current live view size.</i>
CIF Resize			The QVGA resolution is resized to fit into the current live view size. <i>This icon appears only when the selected resolution is QVGA (CIF).</i>
Snapshot		Supervisor / Power User / Normal User	Click to take a snapshot of the current view on a new window. Right click on the picture and re-save it to the location you want.
Full Screen		Supervisor / Power User / Normal User	Click to display the image in full screen. To exit the full screen mode, press "Esc" on your keyboard.
DPTZ		Supervisor / Power User / Normal User	Click to enable digital PTZ functions.
Audio On / Off		Supervisor / Power User / Normal User	Click to switch the audio-in on / off.
Manual Alarm Out		Supervisor / Power User / Normal User	Click to force the connected alarm-out device to work. For example, when your alarm device is a buzzer, click this button and your buzzer will start to sound even if there's no alarm event.

2.3 Digital PTZ (DPTZ) Operations

This camera has PTZ capability, i.e. digital PTZ (hereafter called “DPTZ”), for wide area monitoring.

STEP1: Click “DPTZ” to show the DPTZ control panel.

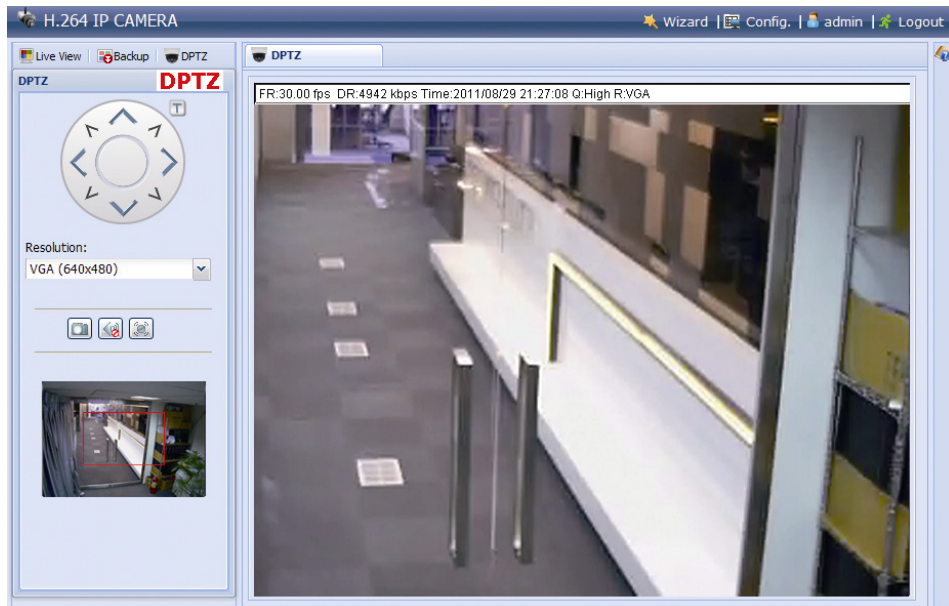

STEP2: Select the functions when needed:

FUNCTION	ICON	DESCRIPTION
Resolution	--	Select the video resolution for the DPTZ function. Only “VGA” and “QVGA” are available.
Take snapshots		Click to take a snapshot of the current view on a new window. Right click on the picture and re-save it to the location you want.
Audio On / Off		Click to switch the audio-in on / off.
Alarm Out		Click to force the connected alarm-out device to work. For example, when your alarm device is a buzzer, click this button and your buzzer will start to sound even if there's no alarm event.

2.4 Event Record Search & Playback

Note: To save more recorded data, it's recommended to use this camera with the compatible NVR.

Time Search

Mode: Time

Start: 2011/08/31 17:52:35

End: 2011/08/31 18:49:27

Download

Calendar Search

Mode: Calendar

2011

Jan Feb Mar Apr May Jun Jul Aug Sep Oct Nov Dec

August

Sun Mon Tue Wed Thu Fri Sat

1 2 3 4 5 6

7 8 9 10 11 12 13

14 15 16 17 18 19 20

21 22 23 24 25 26 27









28 29 30 31

Select Time: 00:00 - 00:00

Start

Event Icon

External Alarm Internal Alarm

	Previous / Next Hour	Click to jump to the next / previous time interval in an hour, for example, 11:00 ~ 12:00 or 14:00 ~ 15:00, and start playing the earliest event video clip recorded during this whole hour.
	Fast Forward	Increase the speed for fast forward. Click to get 2X, 4X, 8X & 16X speed forward eventually.
	Fast Rewind	Increase the speed for fast rewind. Click to get 2X, 4X, 8X & 16X speed rewind eventually.
	Play	Click to play the current video clip.
	Pause	Click to pause the video playback.
	Stop	Click to stop the video playback.
	Step	In the pause mode, click to get one frame forward.
	Audio	Click to mute the playback if necessary, and click again to restore.
	Download	Click to download the current video clip to the specified path in your PC. <i>The downloaded video can only be opened by our own video player. Please go to "General" → "Maintenance" to download the video player, or get the player from the CD supplied with the sales package.</i>

3. CAMERA CONFIGURATIONS

Users can further configure this network camera by accessing via Internet Explorer.

3.1 System configuration menu

Click “Config.” to enter the configuration page.

Note: You need to be “Supervisor” to enter the system configuration page. If you’re not a “Supervisor”, please re-log into the camera with the correct user name and password.

The functions are categorized into six menus: Network, Camera, Record Timer, Storage, Trigger and General.

- For details about “Network”, please refer to “3.2 Network” at page 9.
- For details about “Camera”, please refer to “3.3 Camera” at page 12.
- For details about “Record”, please refer to “3.4 Record” at page 14.
- For details about “Storage”, please refer to “3.5 Storage” at page 15.
- For details about “Trigger”, please refer to “In “Memory”, you can check the remaining capacity for recording, or clear all recorded data saved if needed.

Note: The recorded data will be removed also when you reset or reboot this camera.

For models without a micro SD cart slot, you can only record a limited number of recordings.

For models with a micro SD cart slot, you could insert a compatible micro SD card for more video recording.

Note: To know how and where to insert a micro SD card, please refer to “1.8 Insert a Micro SD Card (Selected Models Only)” at page 3.

To know the compatible list of micro SD cards, please refer to “APPENDIX 5 MICRO SD CARD COMPATIBLE LIST” at page 26.

Note: To save more recorded data, it’s recommended to use this camera with the compatible NVR.

Note: To know the total recording time per recording resolution, please refer to “APPENDIX 4 RECORDING TIME TABLE” at page 25.

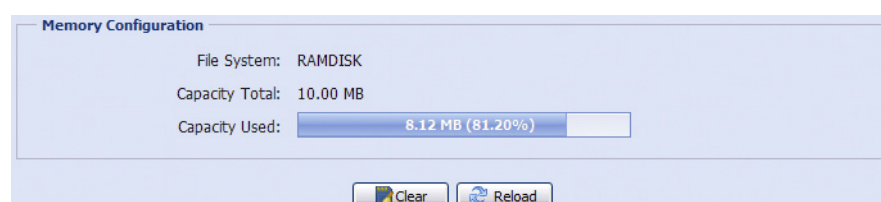

- 3.6 Trigger” at page 15.
- For details about “General”, please refer to “3.7 General” at page 17.

Main Menu	Sub-Menu	Reference
Network	Network	Configure network settings.
	QoS	Limit the data flow for live streaming.
	DDNS	Enter DDNS information when the network type is PPPOE or DHCP.
	SNTP	Synchronize your camera time with the networked computer systems.
	FTP	Enter the FTP information for event notifications when "FTP" is chosen in "Trigger" → "Trigger".
	Mail	Enter Email information for event notifications when "Email" is chosen in "Trigger" → "Trigger".
	Filter	Choose to permit or block the IP address(es) which can access this camera.
	UPnP	<i>*Suitable for Windows-based operating system.</i> Allow this camera to be detected among devices within the same network area for easy and quick usage.
	Bonjour	<i>*Suitable for Apple Mac-based operating system.</i> Allow this camera to be detected among devices within the same network area for easy and quick usage.
Camera	Camera	1. Set the camera title. 2. Specify the display position of the camera title.
	Video	Adjust video-related settings in different video format.
	Color	Adjust the color performance.
	Audio	Adjust the audio volume of the microphone and speaker.
	Advance	Adjust the camera parameters if necessary.
Record	Record	Configure the record function.
	Record Timer	Schedule human detection recording and external alarm recording.
Storage	Memory	Check the current storage capacity and clear all recorded data when needed.
Trigger	Trigger	1. Enable / disable the motion, alarm and PIR detection. 2. Set the motion detection area. 3. Configure how the camera reacts for any event.

Main Menu	Sub-Menu	Reference
General	General	<ol style="list-style-type: none"> 1. Select the language of the web browser. 2. Check the MAC address of the camera. 3. Lock camera access after the specified time. 4. Enable or disable LED status indication.
	Time	Set daylight saving time and the current time.
	Server Log	Check the system event logs.
	Online	Check the current online user(s).
	Account	<ol style="list-style-type: none"> 1. Create a new user account with different access privilege. 2. Modify or delete an existing user account.
	Maintenance	<ol style="list-style-type: none"> 1. Check the current firmware version and upgrade your camera. 2. Copy system configurations. 3. Reboot the camera. 4. Download the video player to play the recorded data.

3.2 Network

3.2.1 Network

You can set the network configuration of the network camera depending on your network type.

For details, please refer to “Advanced Network Setup” from www.surveillance-download.com/user/m301.swf.

The screenshot shows the 'Network Configuration' web interface. It features several input fields and radio buttons. The 'IP Type' section has three options: 'Static IP' (selected), 'PPPoE', and 'DHCP'. Below this, there are fields for 'Server IP' (192.168.1.10), 'Gateway' (192.168.1.1), 'Net Mask' (255.255.255.0), 'Port' (80), 'DNS1' (168.95.1.1), and 'DNS2' (139.175.55.244). A 'MAC Address' field is also present with the value 00:0E:53:20:E7:3E. At the bottom, there are 'Save' and 'Reload' buttons.

3.2.2 QoS

QoS, Quality of Service, is the ability to control the data flow for real-time streaming. This function is important if your network bandwidth is insufficient and you have other devices to share the network bandwidth.

Check “QoS Enable”, and set the max. upload rate from 256 to 10240 kbps.

The screenshot shows the 'QoS Configuration' web interface. It includes a 'QoS' section with 'Enable' (selected) and 'Disable' radio buttons. Below this is an 'Interface' dropdown menu set to 'Ethernet'. A 'Max. Upload Rate' field is set to '4096' kbps. 'Save' and 'Reload' buttons are located at the bottom.

3.2.3 DDNS

Select “On” when the selected network type in “Network” is “PPPOE” or “DHCP”.

For details, please refer to “Advanced Network Setup” from www.surveillance-download.com/user/m301.swf.

The screenshot shows the 'DDNS Configuration' web interface. It features a 'DDNS' section with 'Enable' (selected) and 'Disable' radio buttons. Below this are three input fields: 'System Name' (default), 'Hostname' (MAC000e531d6ff1) with a domain suffix of .ddns.eagleeyes.tw, and 'E-Mail' (manager@tech.com). 'Save' and 'Reload' buttons are at the bottom.

3.2.4 SNTP

SNTP (Simple Network Time Protocol) is used to synchronize your camera time with the networked computer systems.

Function	Description
GMT	Once users choose the time zone, the network camera will adjust the local area time of the system automatically.
NTP Server	Simply use the default SNTP server (For example, tock.stdtime.gov.tw) or change to another server with which users are familiar.
Sync. Period	Select "Daily" to synchronize the camera time with the network time every day or "None" to turn off this function.
Sync	Click and the network camera will synchronize the time with the network time.

3.2.5 FTP

Enter the detailed FTP information and click "Save" to confirm. The information you set here will be applied when "FTP" is selected in "Trigger" → "Trigger".

3.2.6 MAIL

Enter the detailed e-mail information and click "Save" to confirm. The information you set here will be applied when "Email" is selected in "Trigger" → "Trigger".

Function	Description
SMTP Server	Enter the SMTP server address provided from your e-mail system supplier.
Port	Enter the port number provided from your e-mail system supplier. If this column is left blank, the e-mail server will use port 25 to send e-mails.
Mail From	Enter the name of the sender.
SSL Encryption	Select "Yes" if your e-mail server is using SSL encryption to protect your e-mail content from unauthorized access.

Function	Description
Verify Password	Some mail servers are required to verify the password. Please enter the “user name” and “password”.
E-Mail Address List	Add the e-mail address(s) of the assigned recipient(s).
Test	When all information is entered, click “Test Mail” to try if the receipt.

3.2.7 Filter

Choose to permit or block the IP address(es) which can access this camera, and click “Save” to confirm.

Function	Description
Filter Configuration	
Error Count	Set the maximum count for login failure. When the maximum count is reached, the IP address trying to access the network camera will be locked.
Error Lock Time	Set the lock time in minutes when the maximum count of error login for an IP address is reached.
Echo Request	Select “Non-Block” to allow other users to use the ping command to detect the IP address of your network camera, or “Block” to deny the ping command request.
IP/MAC Filter Configuration	
IP/MAC Filter	Choose to enable or disable the filter function.
IP/MAC Filter Policy	If “Enable” is selected, choose whether you want to permit (Allow) or block (Deny) the IP address list below.
IP/MAC Filter Rules	
Rule	<ul style="list-style-type: none"> To add an item to the IP address list, key in the IP address in “Rule”, and click “Add”. To remove an existing item in the IP address list, click the item you want to remove, and click “Delete”.

3.2.8 UPnP / Bonjour

“UPnP” stands for “Universal Plug and Play”, which allows devices to connect seamlessly in the home and corporate environments and simplify installation of computer components, and is only suitable for Microsoft Windows-based operating system.

“Bonjour” functions the same as “UPnP”, but it’s only suitable for Apple Mac-based operating system.

➤ UPnP

➤ Bonjour

Check “Enable” to allow the network camera to be detected among devices within the same network area, and set the identification name of the camera in “Friendly name”.

When this function is activated, the other PC within the same domain as this camera will be able to search this camera in:

- “Network Neighbor” with the identification name set in “Friendly name” for Windows-based PC, or
- “” (finder) or “Bookmark” with the identification name set in “Device Name” for Mac-based PC.

Double-click it to quickly open the web browser for camera access.

Port Mapping (Available only in UPnP)

This function can eliminate the need to additionally access the router for port forwarding.

For details, please refer to “Advanced Network Setup” from www.surveillance-download.com/user/m301.swf.

Note: Before using this function, make sure your router supports UPnP, and this function is enabled. If not, please access your router additionally for port forwarding.

When “Port Mapping” is set to “Enable”, the system will automatically assign an IP address or port number for you if no IP address or port number is entered.

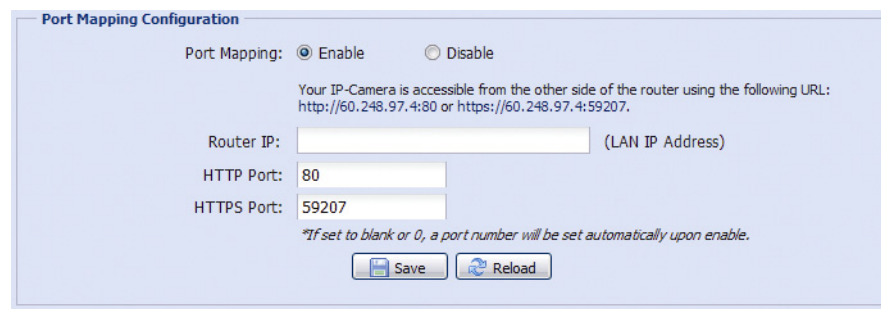

The screenshot shows the "Port Mapping Configuration" window. At the top, "Port Mapping" is set to "Enable" (radio button selected). Below this, a message states: "Your IP-Camera is accessible from the other side of the router using the following URL: http://60.248.97.4:80 or https://60.248.97.4:59207." There are three input fields: "Router IP:" (empty), "HTTP Port:" (80), and "HTTPS Port:" (59207). A note below the ports says: "If set to blank or 0, a port number will be set automatically upon enable." At the bottom are "Save" and "Reload" buttons.

Note: When the configurations are saved successfully, you’ll see a message indicating the IP address and port number assigned to this network camera.

3.3 Camera

3.3.1 Camera

In this menu, you can set the camera title, and specify where to display this title on the display.

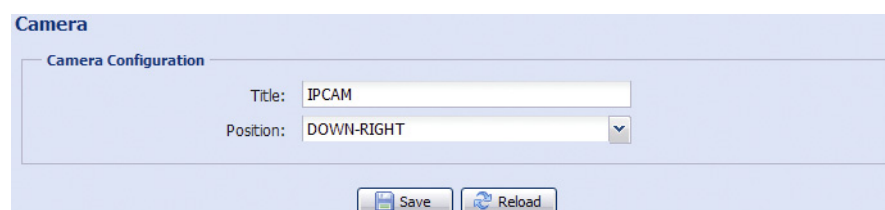

The screenshot shows the "Camera Configuration" window. It has two input fields: "Title:" with the value "IPCAM" and "Position:" with a dropdown menu set to "DOWN-RIGHT". At the bottom are "Save" and "Reload" buttons.

3.3.2 Video

Adjust video-related settings in different video format.

- “Quality” is related to image clearness.
- “FPS” is related to the fluency of the video. The more the FPS, the more fluent the video.
- “Max Bit Rate” is the maximum limitation of data transmission in the selected image format and resolution.

Video Configuration

Configuration

Power Line Frequency: 60 Hz

H264

Resolution	Quality	FPS	Max Bit Rate
SXGA / HD720P	HIGH	30	5000
VGA	HIGH	30	3000
QVGA	HIGH	30	3000
QQVGA	HIGH	30	3000

MPEG4

Resolution	Quality	FPS	Max Bit Rate
SXGA / HD720P	HIGH	20	5000
VGA	HIGH	30	3000
QVGA	HIGH	30	3000
QQVGA	HIGH	30	3000

JPEG

Resolution	Quality	FPS
SXGA / HD720P	HIGH	30
VGA	HIGH	30
QVGA	HIGH	30
QQVGA	HIGH	30

Save Reload

3.3.3 Color

Adjust the color performance from Brightness, Contrast, Hue and Saturation. Click and drag the slider to preview the color change on the right side of this page and adjust the image color.

To restore the default values, click “Back to Default”.

Color Configuration

Brightness: 50

Contrast: 55

Hue: 50

Saturation: 65

Live View

IPCAM

Back to Default Reload

3.3.4 Audio

Drag the slider to adjust the volume of the microphone for audio streaming.

Audio Volume Configuration

Input(Mic.): 5 Mute

Back to Default Reload

3.3.5 Advanced

Adjust the camera parameters if necessary.

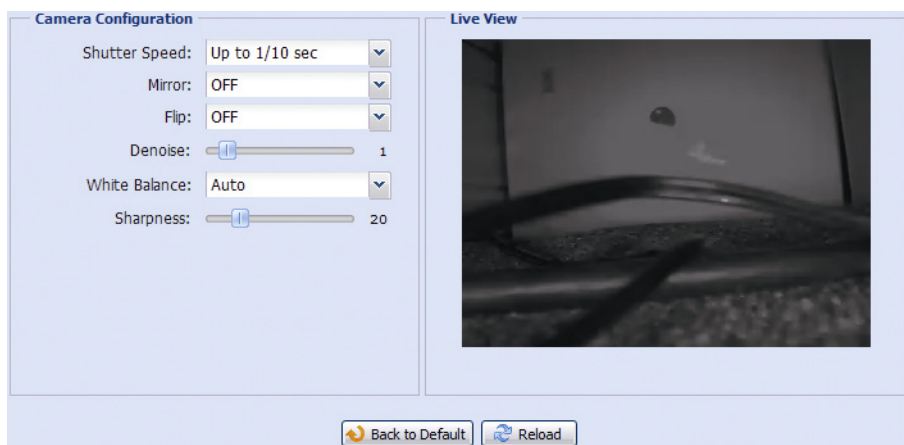

Item	Description
Shutter Speed	Set the shutter speed based on your need. The options are: Up to 1/10 sec, Up to 1/30, Up to 1/15, Up to 1/6, Up to 1 and Up to 2.
Mirror	Select "ON" to rotate the images horizontally based on your installation situation when necessary.
Flip	Select "ON" to rotate the image 180° when necessary.
De-noise	Click and drag the slider to adjust the level from 0 ~ 10 to decrease the noise shown in the dark environment.
White Balance	Process the current image to retain color balance over a color temperature range. The options are: Auto, Incandescent Light, Cool Light, sun Light, Cloudy & Sun Shade.
Sharpness	Sharpness enhances the clarity of image detail by adjusting the aperture and sharpening the edges in the pictures. Hold and drag the slider to adjust the level of sharpness from 0 ~ 100. The higher the value, the sharper the image.

3.4 Record

3.4.1 Record

In "Record Configuration", you can:

- Enable or disable the alarm record function. When "Enable" is set to "No", the alarm record function is disabled even if you enable it in other configuration pages.
- Select if the data should be overwritten when the memory storage is full.
- Enable or disable the audio record function.
- Select the video resolution for event recording.

Note: Based on the model you have, the options for "Record Resolution" might be different from the images shown below.

Note: The higher resolution you choose, the more accuracy and higher image quality the recording will be, but the faster the memory storage is consumed and become full.

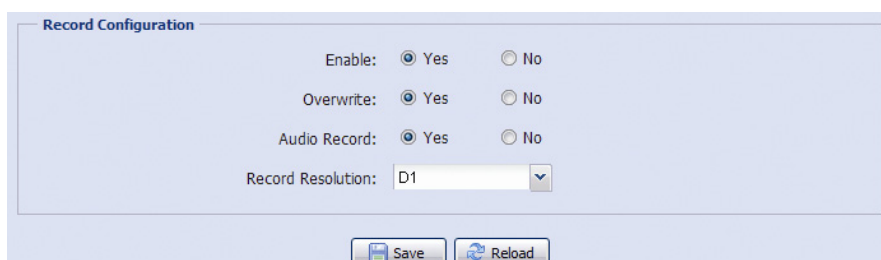

3.4.2 Record Timer

To schedule alarm recording or human detection recording, click “External Alarm” or “Internal Alarm” (human detection) to enable the recording, and select the day and time for recording.

Note: The timer must be enabled for the record function to work properly.

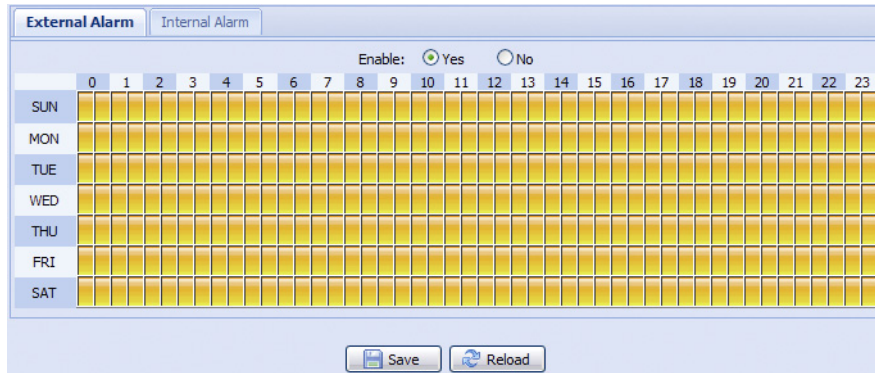

3.5 Storage

3.5.1 Memory

In “Memory”, you can check the remaining capacity for recording, or clear all recorded data saved if needed.

Note: The recorded data will be removed also when you reset or reboot this camera.

For models without a micro SD card slot, you can only record a limited number of recordings.

For models with a micro SD card slot, you could insert a compatible micro SD card for more video recording.

Note: To know how and where to insert a micro SD card, please refer to “1.8 Insert a Micro SD Card (Selected Models Only)” at page 3.

To know the compatible list of micro SD cards, please refer to “APPENDIX 5 MICRO SD CARD COMPATIBLE LIST” at page 26.

Note: To save more recorded data, it’s recommended to use this camera with the compatible NVR.

Note: To know the total recording time per recording resolution, please refer to “APPENDIX 4 RECORDING TIME TABLE” at page 25.

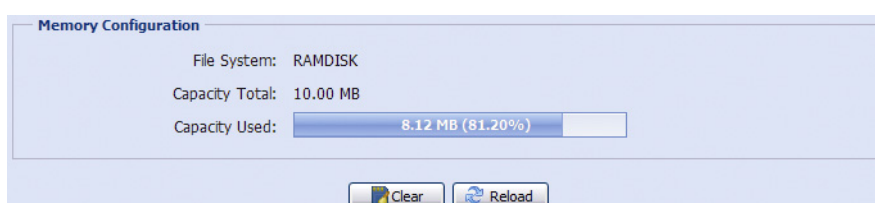

3.6 Trigger

3.6.1 Trigger

You can configure how this camera reacts when there’s an alarm, a motion or a PIR event.

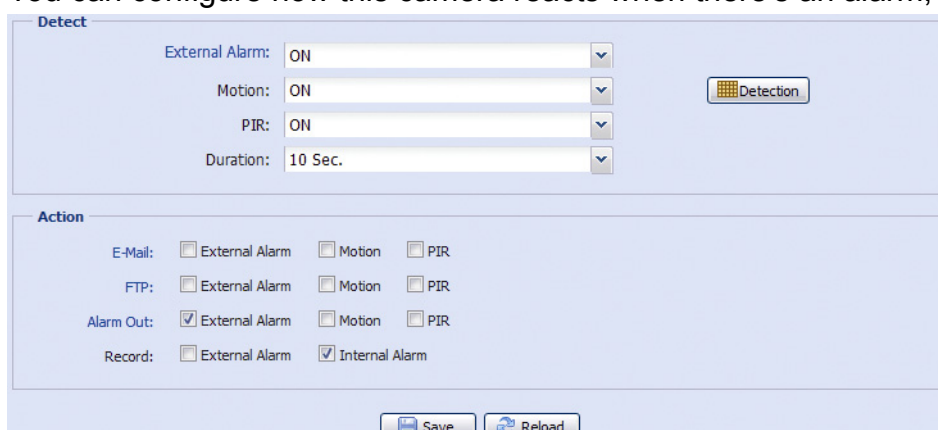

◆ Detect

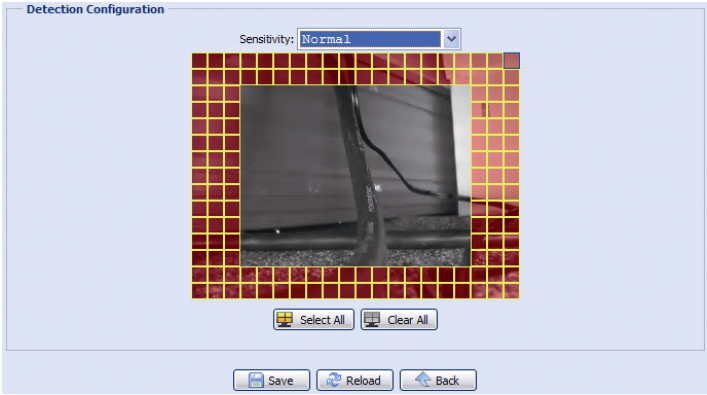
Item	Description
External Alarm	Enable or disable detection from external alarm-in device, and click the title "External Alarm" (in blue) to set "N.O." or "N.C." depending on the configuration of your alarm-in device.
Motion	<p>Enable or disable motion detection. <i>Motion detection is not supported when the stream format is Motion JPEG.</i></p> <p>When "ON" is selected, click "Detection" to enter the motion detection area setting page as follows:</p>  <p>Sensitivity: Set the detection sensitivity from the drop-down list: High, Normal or Low.</p> <p>Area Setting: Set the motion detection area by selecting the area grids with your mouse. Pink grids represent the area that is not being detected while the transparent grids are the area under detection. You can set multiple areas under detection. Click "Clear All" to set the whole area undetected. Click "Select All" to set the whole area under detection.</p>
PIR	Enable (ON) or disable (OFF) PIR detection.
Duration	Set the duration time for trigger recording (5 / 10 / 20 / 40 seconds).

◆ Action

Here defines how the camera delivers alerts to you for any event.

Item	Description
E-Mail	<p>Select the event type you want to receive E-mail notifications when it occurs. Then, click the title "E-Mail" (in blue) to configure the media type (H264 / JPEG / MPEG4), file format (AVC / AVI), and record time (1 ~ 5 seconds) for the event video clip. The camera will send the captured video clip to the E-mail address(s) you assigned in "Network" → "Mail" once the selected event type occurs.</p>
FTP	<p>Select the event type you want to receive FTP notifications when it occurs. Then, click the title "FTP" (in blue) to configure the media type (H264 / JPEG / MPEG4), file format (AVC / AVI), and record time (1 ~ 5 seconds) for the event video clip. The camera will upload the captured video clip to the FTP site you assigned in "Network" → "FTP" once the selected event type occurs.</p>
Alarm Out	<p>Select the event type you want to trigger the alarm-out device to work when it occurs. Then, click the title "Alarm Out" (in blue) to configure the trigger rule (LOW / HIGH).</p>
Record	Select the event type you want to enable event recording when it occurs.

3.7 General

3.7.1 General

To change the language of UI interface, select from the drop-down list in “Language”.

To allow the status LED indicators to show the status as indicated in “1.6 Status Indicator” at page 2, select “Enable” in “Status LED Mode”; to hide the status, select “OFF”; to only show the error status, select “Temporary Disable”.

Note: The status LED mode will be restored to “Enable” after camera reboot when “Temporary OFF” is selected.

To lock camera access when it’s not used after the specified time, select “5 MIN”, “15 MIN” or “30 MIN” from the drop-down list of “Auto Lock Time”, or select “NEVER” to disable this function.

Note: When the camera access is locked after the specified time, to resume camera access, please enter the password.

General

General Configuration

Language: English

Status LED Mode: Enable

Auto Lock Time: 15 MIN

MAC Address: 00:0E:53:E6:29:B3

Save Reload

3.7.2 Time

Set daylight saving time and the current time, and click “Save” to confirm.

Time

Time Configuration

OSD: Enable Disable

Date: 2011/08/30

Time: 21 : 16 : 41

Save Reload

Daylight Saving Time

Daylight Saving Time Configuration

Daylight Saving Time: Enable Disable

Start Time: August First Week Monday 6 : 0 (HH:MM)

End Time: October Fifth Week Monday 10 : 0 (HH:MM)

Adjust Time: 1 : 0 (HH:MM)

Save Reload

Function	Description
■ Time Configuration	
Date	Set the current date.
Time	Set the current time.
■ Daylight Saving Time Configuration	
Daylight Saving Time	Specify whether to use daylight saving time (Enable / Disable).
	If this function is enabled, set the time period (Start Time / End Time), and adjust the daylight saving time in hours (Adjust Time).

3.7.3 Server Log

To quickly search the system logs you want by event type, click “Prev. Page” or “Next Page” to find the logs you want, or check the event type(s) and click “Reload” to start searching.

To clear all system event logs, click “Clear All”.

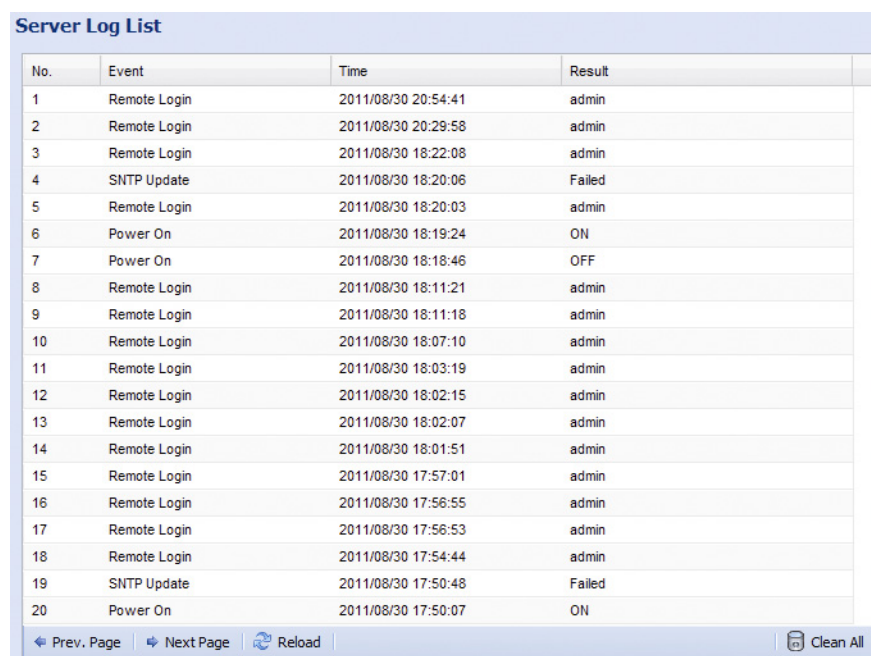

Server Log List

No.	Event	Time	Result
1	Remote Login	2011/08/30 20:54:41	admin
2	Remote Login	2011/08/30 20:29:58	admin
3	Remote Login	2011/08/30 18:22:08	admin
4	SNTP Update	2011/08/30 18:20:06	Failed
5	Remote Login	2011/08/30 18:20:03	admin
6	Power On	2011/08/30 18:19:24	ON
7	Power On	2011/08/30 18:18:46	OFF
8	Remote Login	2011/08/30 18:11:21	admin
9	Remote Login	2011/08/30 18:11:18	admin
10	Remote Login	2011/08/30 18:07:10	admin
11	Remote Login	2011/08/30 18:03:19	admin
12	Remote Login	2011/08/30 18:02:15	admin
13	Remote Login	2011/08/30 18:02:07	admin
14	Remote Login	2011/08/30 18:01:51	admin
15	Remote Login	2011/08/30 17:57:01	admin
16	Remote Login	2011/08/30 17:56:55	admin
17	Remote Login	2011/08/30 17:56:53	admin
18	Remote Login	2011/08/30 17:54:44	admin
19	SNTP Update	2011/08/30 17:50:48	Failed
20	Power On	2011/08/30 17:50:07	ON

◀ Prev. Page ▶ Next Page ↻ Reload 🗑 Clean All

3.7.4 Online

You can check the current online user(s) with respective online information. To refresh the list, click “Reload”.

- To allow anonymous login, select “Enable” in “Anonymous Viewer Login”.
- To disable image code verification at login, select “No” in “Login with CAPTCHA Image”.

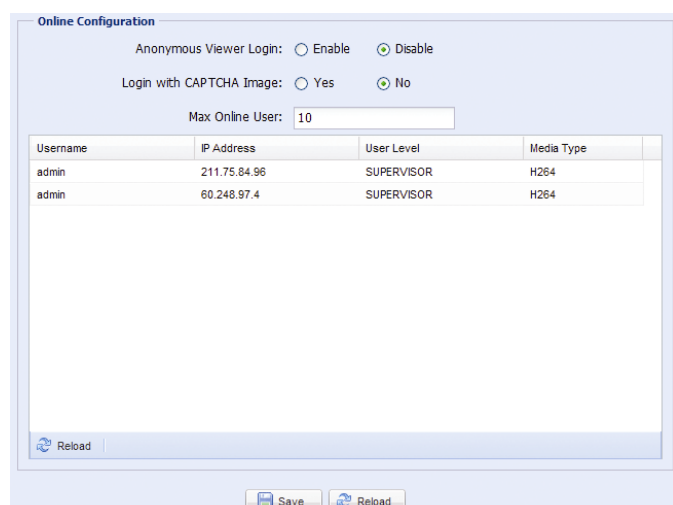

Online Configuration

Anonymous Viewer Login: Enable Disable

Login with CAPTCHA Image: Yes No

Max Online User:

Username	IP Address	User Level	Media Type
admin	211.75.84.96	SUPERVISOR	H264
admin	60.248.97.4	SUPERVISOR	H264

↻ Reload

💾 Save ↻ Reload

3.7.5 Account

You can create a new account with different user access privilege, or delete or modify an existing account setting.

How to create a new account

Step1: Click “New”, and fill in the following columns.

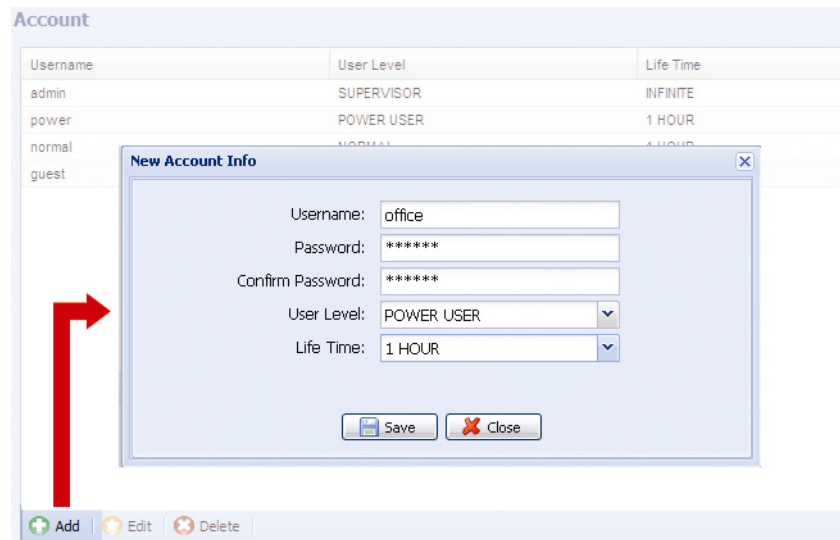

Column	Description
User Name	Set a user name that will be used for camera access. The user name allows up to 16 alphanumeric characters.
Password	Set the password that will be used for remote login. The password allows up to 16 alphanumeric characters.
Confirm Password	Enter the password again to confirm.
User Level	Set the security level of an account to give the permission to control different functions. There are four user levels: SUPERVISOR, POWER USER, NORMAL USER and GUEST.
Life Time	Select how long this account is allowed to stay online (1 MIN / 5 MIN / 10 MIN / 1 HOUR / 1 DAY / INFINITE)

Step2: Then, click “Save” to save your setting and create a new account.

How to modify or delete an existing account

Step1: Select the account you want to modify or delete.

Step2: To modify the account, click “Edit” to change the settings, and click “Save”.

To remove the account, click “Delete”.

Note: It's not allowed to remove an account when there's only one account in the account list.

3.7.6 Maintenance

Firmware Upgrade

This function is used when users need to upgrade the camera for function scalability.

Note: Before using this function, make sure you have the correct upgrade files provided by your installer or distributor.

Note: The event videos saved in the camera will be removed after firmware upgrade. Make sure you've copied important events to your PC before firmware upgrade.

Step1: Select “” to browse to where you save the upgrade files, and select them one by one until all files are selected (up to four files).

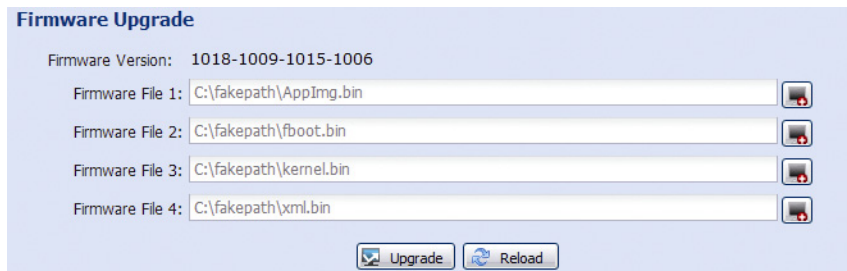

Step2: Select “Upgrade” to start system upgrading.

Note: You’ll be prompted to keep current configurations. It’s recommended to keep them, or all configurations will be restored to default values after upgrade.

Note: It takes a few minutes to finish the upgrade process. Do not disconnect the power during firmware upgrade, or the upgrade may be failed. The camera will reboot after the upgrade.

System Configuration Backup

This function is used to copy your system configuration to a “System.bin” file.

You may import the same system configuration to another camera, or restore your system configuration when the camera is reset to default values.

Select “System.bin” in “Firmware Upgrade”, and select “Upgrade” to import the system configuration.

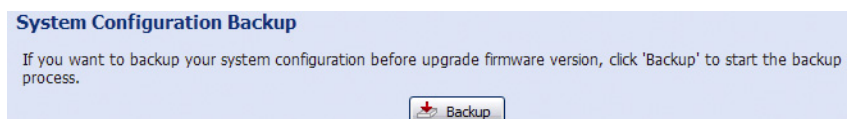

System Reboot

Select “Reboot” to restart your camera if needed.

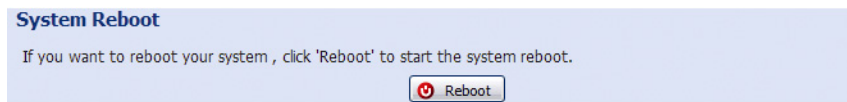

Player Download

To see the event video clips downloaded to your PC, you need to first install our own video player in your PC. Select “Free Download” to download the video player, and double click the file to install it.

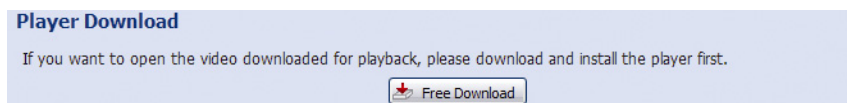

APPENDIX 1 PRODUCT SPECIFICATIONS

	Model 1	Model 2	Model 3
■ Network			
LAN Port	YES		
LAN Speed	10/100 Based-T Ethernet		
Supported Protocols	DDNS, PPPoE, DHCP, NTP, SNTP, TCP/IP, ICMP, SMTP, FTP, HTTP, RTP, RTSP, RTCP, IPv4, Bonjour, UPnP, DNS, UDP, IGMP, QoS		
ONVIF Compatible	YES		
Number of Online Users	10		
Security	<ol style="list-style-type: none"> Multiple user access levels with password IP address filtering Digest authentication 		
Remote Access	<ol style="list-style-type: none"> Internet Explorer on Windows operating system EagleEyes on iPhone, iPad and Android mobile devices 		
■ Video			
Network Compression	H.264 / MPEG4 / MJPEG		
Frame Rate	NTSC:30, PAL:25		
Video Resolution	SXGA, HD720P, VGA, QVGA		
Multiple Video Streaming (Encode Modes, IPS, Resolution)	4 (H.264, MJPEG, MPEG4)		
■ Camera			
Image Sensor	1/4" SONY H.R. image sensor		
Min Illumination	0.1 Lux / F1.5		
Shutter Speed	1/2 to 1/10,000 sec		
S/N Ratio	More than 48dB (AGC off)		
Lens	f3.8mm / F1.5		
Viewing Angle	53.7°(Horizontal) / 34.1°(Vertical) / 62.7°(Diagonal)		
PIR Range	Detection Range 76° wide angle with up to 6m long distance at 2m height (under 30°C)		
White Balance	ATW		
AGC	Auto		
IRIS Mode	AES		
External Alarm I/O	YES		
Micro SD Card Slot	NO	YES	
Operating Temperature	0°C~40°C		
Power Source (±10%)	5V / 1A		12V / 1A
Current consumption (±10%)	--		0.25A
■ Audio			
Microphone built-in	YES		
■ Others			
Mobile Surveillance	iOS & Android devices		
RTC (real-time clock)	YES		
Motion Detection	YES		
Digital Pan / Tilt / Zoom	YES		
Event Notification	FTP / Email		
Minimum Web Browsing Requirements	<ul style="list-style-type: none"> Intel core i3 or higher, or equivalent AMD 2GB RAM AGP graphics card, Direct Draw, 32MB RAM Windows 7, Windows Vista & Windows XP, DirectX 9.0 or later Internet Explorer 7.x or later 		

** The specifications are subject to change without notice.

** Dimensional tolerance: ± 5mm

APPENDIX 2 BIT RATE TABLE FOR REFERENCE

The data below is for reference only.

The bit rates listed here may vary depending on the resolution, image quality & frame rate you choose, the complexity of your monitoring area, and how often the moving objects show in your monitoring area.

Testing Environment

- Place: Office Entrance
- Network translation: H.264
- Camera type: Megapixel camera

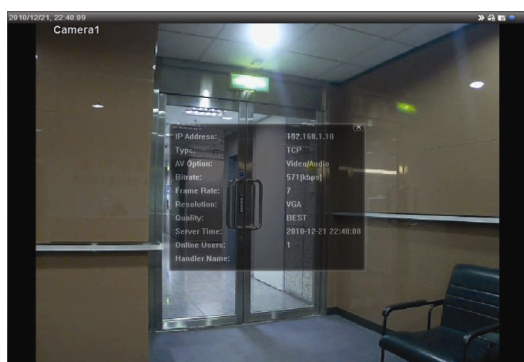

Static: No one coming in and out



Dynamic: One or two people coming in and out

Resolution	Quality	Frame Rate	(Dynamic) kbps	(Static) kbps
SXGA	Best	FULL	3253	3216
	High		2375	2160
	Normal		1571	1266
	Basic		1465	873
VGA	Best		2010	1261
	High		1042	1034
	Normal		685	572
	Basic		457	350
QVGA	Best		646	366
	High		482	350
	Normal		302	286
	Basic		168	161
SXGA	Best	1/4	1163	1076
	High		989	715
	Normal		855	534
	Basic		719	443
VGA	Best		789	571
	High		451	447
	Normal		349	237
	Basic		217	165
QVGA	Best		269	147
	High		182	131
	Normal		164	113
	Basic		97	71

Resolution	Quality	Frame Rate	(Dynamic) kbps	(Static) kbps
SXGA	Best	1/15	581	374
	High		405	342
	Normal		487	248
	Basic		337	141
VGA	Best		358	79
	High		201	63
	Normal		180	28
	Basic		92	15
QVGA	Best		111	84
	High		99	68
	Normal		97	54
	Basic		58	42

APPENDIX 3 Q&A

For more details about EagleEyes Q&A, please visit our official website, www.eagleeyesccctv.com.

Question	Answer
<p>I can connect to this camera in my house or office where it's installed with wireless network.</p> <p>But when I leave my house or office, I can't connect to it from my mobile phone (with 3G network), or other PC (connected to Internet). Why?</p>	<p>You didn't configure this camera to Internet, but only in LAN.</p> <p>Please follow the steps in the advanced network setup guide downloadable from www.surveillance-download.com/user/m301.swf to complete network configurations, or it's recommended for you to check with your local installer or reseller for this service because it's usually hard for a person who doesn't have network knowledge to set network configurations.</p>
<p>My live images are not fluent. Why?</p>	<p>Image fluency could be affected by the local network upload bandwidth, router efficiency, client network download bandwidth, complexity of live view, and more.</p> <p>(Recommended) To have the best image fluency, select QVGA; to have the best image quality, select "SXVGA"; to have normal image fluency and quality, select "VGA".</p>
<p>The detection range of the built-in human detection sensor seems too short and the sensor is not sensitive enough. Did I do anything wrong on installation?</p>	<p>The human detection sensor might be influenced by the temperature of ambient environment and human beings, and the applicable working temperature is up to 30°C. To get more accurate and precise detection, you may connect external alarm devices, such as magnetic contacts.</p>
<p>The live video keeps flickering. Why?</p>	<p>Please try adjusting the power line frequency to "60 Hz" or "50 Hz" for the camera.</p> <p>For iPhone users, access the camera, and select "" on the top right corner to enter IPCAM Configuration page. Then, go to "Advance Setup" → "Camera" to change setting.</p> <p>For access from Internet Explorer, log into the camera, and select "Config." → "Camera" → "Camera".</p>

APPENDIX 4 RECORDING TIME TABLE

Below shows the estimated total recording time for each recording resolution.

The recording time per resolution is the average value collected from the both alarm trigger conditions indicated in “Testing Environment”, and is for reference only.

The time may vary depending on the resolution, image quality & frame rate you choose, the complexity of your monitoring area, and how often the moving objects show in your monitoring area.

Testing Environment

- Place: Office
- Monitoring area: 1.5 meters away from the camera
- Alarm trigger conditions:
 - (1) One person walks by the monitoring area and leaves immediately.
 - (2) Two persons walk by the monitoring area. One goes away immediately, and the other one stays a while and goes away.

Recording Resolution	SXGA	VGA	QVGA
Recording time (second)	25	115	211

APPENDIX 5 MICRO SD CARD COMPATIBLE LIST

Manufacturer	Capacity	Class	Manufacturer	Capacity	Class
ADATA	2GB	--	Transcend	2GB	--
	4GB	Class 6		4GB	Class 2
Apacer	2GB	--		4GB	Class 4
	4GB	Class 4		4GB	Class 6
SanDisk	2GB	--		8GB	Class 6
	4GB	Class 4	16GB	Class 10	
	8GB	Class 4	Kingston	2GB	--
	16GB	Class 4		4GB	Class 4
	32GB	Class 4		8GB	Class 4
Verico	2GB	--		32GB	Class 4
	4GB	Class 4	TOSHIBA	16GB	Class 4
	16GB	Class 10	TOPRAM	32GB	Class 10

網路攝影機系列

操作指南

在使用本機前請務必詳細閱讀安全須知及操作說明，並保存此手冊以備後續參考。

安全須知



本公司提供的所有無鉛產品皆符合歐盟有害物質使用限制指引 (Restriction of Hazardous Substances, (RoHS))，意即本公司的生產流程與產品均嚴格遵守無鉛守則，而且不包含該指引內提供的任何有害物質。



此劃叉的滾輪垃圾筒圖示代表在歐盟境內，本產品於丟棄時必須另行收集。此原則適用於您的產品與任何標有此圖示的週邊設備。請勿隨意丟棄這些產品。請洽詢您當地的經銷商，以得知回收此設備的程序。



本裝置製造過程符合無線電干擾要求。

FCC (Federal Communications Commission) 聲明

This equipment has been tested and found to comply with the limits for a Class B digital service, pursuant to Part 15 of the FCC rules. These limits are designed to provide reasonable protection against harmful interference in a residential installation.

Any changes or modifications made to this equipment may void the user's authority to operate this equipment. This equipment generates, uses, and can radiate radio frequency energy. If not installed and used in accordance with the instructions, may cause harmful interference to radio communications. However, there is no guarantee that interference will not occur in a particular installation. If this equipment does cause harmful interference to radio or television reception, which can be determined by turning the equipment off and on, the user is encouraged to try to correct the interference by one or more of the following measures:

- Reorient or relocate the receiving antenna.
- Increase the separation between the equipment and receiver.
- Connect the equipment into an outlet on a circuit different from that to which the receiver is connected.
- Consult the dealer or an experienced radio/TV technician for help.

This device complies with Part 15 of the FCC Rules. Operation is subject to the following two conditions:

- (1) This device must not cause harmful interference, and
- (2) This device must accept any interference received, including interference that may cause undesired operation.

FCC Caution:

- Any changes or modifications not expressly approved by the party responsible for compliance could void the user's authority to operate this equipment.
- All external cables connecting to this basic unit must be shielded.
For cables connecting to PCMCIA cards, see the option manual or installation instructions.

商標聲明

iPad®、iPhone® 是 Apple Inc. 的註冊商標。

Android™ 是 Google Inc. 的商標。此商標的使用必須依 Google Permissions 的規定使用。

Microsoft®、Windows® 和 Internet Explorer® 是 Microsoft Corporation 在美國和 / 或其他國家的註冊商標。

Opera 為 Opera Software 的商標或註冊商標。

免責聲明

本公司保留可隨時修改或刪除說明書內容的任何權利。本公司不保證此說明書的內容完全無誤、完整或實用。此說明書內容更改以實際產品為準，將不另行通知。

本產品不支援待機模式

MPEG-4 授權

THIS PRODUCT IS LICENSED UNDER THE MPEG4 VISUAL PATENT PORTFOLIO LICENSE FOR THE PERSONAL AND NON-COMMERCIAL USE OF A CONSUMER FOR (i) ENCODING VIDEO IN COMPLIANCE WITH THE MPEG4 VISUAL STANDARD ("MPEG-4 VIDEO") AND/OR (ii) DECODING MPEG4 VIDEO THAT WAS ENCODED BY A CONSUMER ENGAGED IN A PERSONAL AND NON-COMMERCIAL ACTIVITY AND/OR WAS OBTAINED FROM A VIDEO PROVIDER LICENSED BY MPEG LA TO PROVIDE MPEG4 VIDEO. NO LICENSE IS GRANTED OR SHALL BE IMPLIED FOR ANY OTHER USE. ADDITIONAL INFORMATION INCLUDING THAT RELATING TO PROMOTIONAL INTERNAL AND COMMERCIAL USES AND LICENSING MAY BE OBTAINED FROM MPEG LA, LLC. SEE [HTTP://WWW.MPEGLA.COM](http://www.mpegla.com).

GPL 授權



This product contains codes which are developed by Third-Party-Companies and which are subject to the GNU General Public License ("GPL") or the GNU Lesser Public License ("LGPL").

The GPL Code used in this product is released without warranty and is subject to the copyright of the corresponding author.

Further source codes which are subject to the GPL-licenses are available upon request.

We are pleased to provide our modifications to the Linux Kernel, as well as a few new commands, and some tools to get you into the code. The codes are provided on the FTP site, and please download them from the following site or you can refer to your distributor:

<http://download.dvrtw.com.tw/GPL/IPCAM/F-Series/linux.tar.gz>

目錄

1. 產品概述.....	1
1.1 產品特點.....	1
1.2 包裝明細.....	1
1.3 產品概觀.....	1
1.4 背板.....	1
1.5 外接 I/O 裝置埠.....	2
1.6 狀態指示燈.....	2
2. 使用 INTERNET EXPLORER 登入攝影機.....	3
2.1 登入攝影機.....	3
2.2 控制面板簡介.....	3
2.3 DPTZ 操作.....	5
2.4 錄影事件搜尋與回放.....	6
3. 攝影機設定.....	7
3.1 系統設定選單.....	7
3.2 網路設定.....	8
3.2.1 網路設定.....	8
3.2.2 QoS.....	8
3.2.3 DDNS.....	8
3.2.4 網路對時.....	9
3.2.5 影像上傳.....	9
3.2.6 郵件管理.....	9
3.2.7 過濾器.....	10
3.2.8 UPnP / Bonjour.....	10
3.3 攝影機設定.....	11
3.3.1 攝影機設定.....	11
3.3.2 影像設定.....	11
3.3.4 聲音設定.....	12
3.3.5 進階設定.....	13
3.4 定時錄影.....	13
3.4.1 錄影.....	13
3.4.2 定時錄影.....	13
3.5 儲存裝置.....	14
3.5.1 記憶體.....	14
3.6 觸發設定.....	15
3.6.1 觸發設定.....	15
3.7 常用設定.....	16
3.7.1 常用設定.....	16
3.7.2 時間設定.....	17
3.7.3 系統日誌.....	17
3.7.4 連線使用者.....	18
3.7.5 權限管理.....	18
3.7.6 系統維護.....	19
附錄 1 產品規格.....	21
附錄 2 傳輸速度參照表.....	22
附錄 3 常見問題集.....	24

1. 產品概述

1.1 產品特點

- 使用 **iPhone / iPad**，快速完成**網路設定**
- **130 萬畫素**的 LIVE MOS 感應元件並支援 **HDTV 720p**，讓使用者能看到更細微的內容
- 支援**外接警報裝置**
- 內建麥克風**收音**
- **遠端監控**
 - 可由 **iPhone & iPad**，以及 Windows® 作業系統的 **Internet Explorer®** 進行遠端監

1.2 包裝明細

- | | | |
|--|--------------------------------|---------------------------------------|
| <input type="checkbox"/> 網路攝影機 | <input type="checkbox"/> 攝影機支架 | <input type="checkbox"/> 4 PIN/I/O 端子 |
| <input type="checkbox"/> 快速設定指南 (使用 iPhone / iPad) | <input type="checkbox"/> 變壓器 | |

1.3 產品概觀

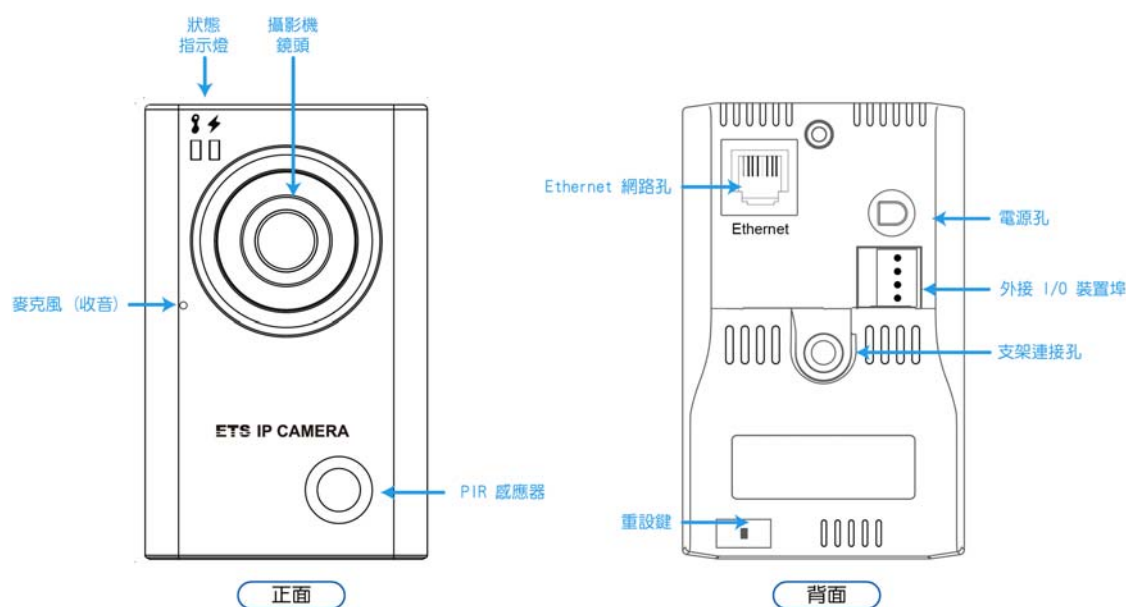

1.4 背板

Ethernet 網路孔：	連接網路線。
電源孔：	連接隨附的電源變壓器。
重設鍵：	在攝影機上電的情況下，長按此鍵會重設所有參數回原廠設定值，包括 IP 位址。 重設完成後，攝影機會重新啓動。請勿在攝影機重設期間拔除攝影機電源。
外接 I/O 裝置埠：	攝影機有隨附一個 4 PIN 的 I/O 端子，專門用來外接警報裝置。詳情請參閱第 2 頁的「1.5 外接 I/O 裝置埠」。

1.5 外接 I/O 裝置埠

攝影機有隨附提供一個 4 PIN 的外接 I/O 端子，讓您可以輕鬆連接到警報裝置。

下圖顯示 I/O 端子各個連接 PIN 腳的用途，以及連接 Alarm Out 裝置的接線示意圖。

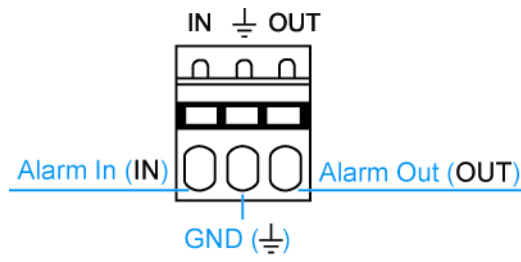

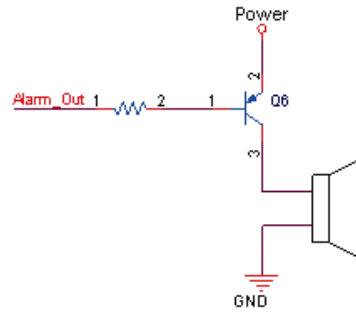

4 PIN I/O 端子



Alarm Out 連接示意圖

1.6 狀態指示燈

圖示	 LAN 區網連線狀態	 Internet 連線狀態
系統狀態		
在開機時	恒亮	恒亮
回復原廠值	閃爍 (亮 250 毫秒，滅 250 毫秒) ●○○●○○●○○●○○	恒滅
升級	閃爍 (亮 250 毫秒，滅 250 毫秒) ●○○●○○●○○●○○	閃爍 (亮 250 毫秒，滅 250 毫秒) ●○○●○○●○○●○○
連線狀態		
區網已連線	恒亮	--
區網斷線	閃爍 (亮 100 毫秒，滅 500 毫秒) ●○○●○○●○○●○○	--
Internet 已連線	--	恒亮
Internet 斷線	--	閃爍 (亮 100 毫秒，滅 500 毫秒) ●○○●○○●○○●○○
3G 連線錯誤 (iPhone / iPad / Android 行動裝置)		
3G 連線設定未完成	--	閃爍 (亮 5 秒、滅 0.5 秒、亮 0.5 秒、滅 0.5 秒、亮 5 秒) ●●●●○○●●●●

* LED 燈閃爍頻率示意 - ● LED 燈亮 / ○ LED 燈滅

2. 使用 INTERNET EXPLORER 登入攝影機

視您的使用環境而定，您可以使用 Microsoft® Internet Explorer® 登入此攝影機，或者在 iPhone / iPad / Android 行動裝置安裝本公司研發的行動小程序 EagleEyes 來進行登入。

註：如需得知使用 iPhone / iPad / Android 行動裝置登入此攝影機的詳細資訊，請參閱 <http://www.eagleeyesctv.com>。

在使用此攝影機之前，請先確認您已做好網路設定，而且網路連線正常。

如需得知網路設定的相關資訊，請參閱：

- 隨附攝影機提供的「快速設定 (使用 iPhone / iPad)」– 若您有 iPhone / iPad，而且您是使用無線網路來上網
- 「進階網路設定」，可從 www.surveillance-download.com/user/m301.swf 下載 – 若您不是使用無線網路來上網

2.1 登入攝影機

步驟 1：開啓您的網路瀏覽器，然後在位址列輸入 [http://IP 位址:埠號](http://IP位址:埠號)。

舉例來說，若 IP 位址為 60.121.46.236 且埠號為 888，請在 URL 網址列中輸入 <http://60.121.46.236:888>，然後按 Enter。

步驟 2：在登入頁面中，輸入預設的使用者名稱和密碼，然後輸入下圖顯示的驗證碼。接著，按 [LOGIN] 登入。

步驟 3：設定精靈隨即啓動。

- 若要離開精靈並直接登入攝影機，請按 [關閉]。
- 若不要在每次登入時都啓動精靈，而是直接進入攝影機畫面，請按 [登入時不啓動精靈]。

註：若系統要求您安裝「VLC player」、「Software」和「H264 Streaming Viewer」，請同意完成安裝。

步驟 5：登入成功後就會看到即時畫面。

2.2 控制面板簡介

註：視登入權限的不同，可使用的按鈕也會不同。



功能	圖示	使用者權限	說明
即時影像		系統使用者 / 超級使用者 / 一般使用者 / 訪客	切換到即時影像頁面。
備份		系統使用者 / 超級使用者	進入事件錄影清單，搜尋要播放的錄影檔案。 詳情請參閱第 6 頁的「2.4 錄影事件搜尋與回放」。
DPTZ		系統使用者 / 超級使用者 / 一般使用者	切換到 DPTZ 設定頁面。 詳情請參閱第 5 頁的「2.3 DPTZ 操作」。
系統設定		系統使用者	切換到系統設定頁面；使用「系統使用者」和「超級使用者」登入時看到的功是是不同的。 詳情請參閱第 7 頁的「3.1 系統設定選單」。
即時播放器	--	系統使用者 / 超級使用者 / 一般使用者 / 訪客	從下拉式清單選擇播放軟體： <ul style="list-style-type: none"> ■ H.264 / MPEG-4 / Motion JPEG ■ QuickTime <p>QuickTime 是 Apple 公司的多媒體播放軟體。在選取 QuickTime 之前，您必須先將 QuickTime 安裝到您的作業系統。選取 QuickTime 後，系統會提示您輸入使用者名稱和密碼來登入攝影機。</p> <ul style="list-style-type: none"> ■ VLC
影像品質	--	系統使用者 / 超級使用者 / 一般使用者	按住並拖曳滑桿來選取影像畫質：低 / 一般 / 高 / 最好。
影像規格	--	系統使用者 / 超級使用者 / 一般使用者	從下拉式選單選取影像解析度： <ul style="list-style-type: none"> <li style="width: 50%;">■ SXGA (1280 x 1024) <li style="width: 50%;">■ HD720P (1280 x 720) <li style="width: 50%;">■ QVGA (320 x 240) <li style="width: 50%;">■ VGA (640 x 480)
即時影像顯示方式		系統使用者 / 超級使用者 / 一般使用者	
全螢幕			按此鈕來全螢幕顯示影像。 若要離開全螢幕顯示，請按一下鍵盤上的 [Esc] 鍵。
CIF 調整大小			QVGA 影像大小已被重新調整以符合螢幕尺寸。 當選取的影像規格為 QVGA 或 CIF 時，才能使用此功能。
原來大小			目前影像大小與選取的影像規格相符。
符合螢幕大小			選取的影像大小已被重新調整以符合螢幕尺寸。 當選取的影像規格為 QVGA 或 VGA，才能使用此功能。
拉框檢視			按住即時影像左下角的可移動方框來移動畫面。 當選取的影像規格為 SXGA / HD720P 或 HD1080P，才能使用此功能。
快照		系統使用者 / 超級使用者 / 一般使用者	截取即時影像的畫面；影像檔會顯示於新視窗，按右鍵點選圖像，將圖像儲存在您指定的位置。
聲音開 / 關		系統使用者 / 超級使用者 / 一般使用者	開啓或關閉收音功能。
警報發出		系統使用者 / 超級使用者 / 一般使用者	強制警報裝置啓動。例如，若您連接了一台蜂鳴器，一旦按下此鈕，就算沒有發生警報，警鳴器也會放聲大響。



2.3 DPTZ 操作

此攝影機擁有所謂的數位 PTZ 功能 (之後都稱「DPTZ」)，讓使用者能看到更清楚的畫面。

步驟 1：按 [DPTZ] 顯示 DPTZ 控制面板。



步驟 2：選擇您想使用的功能：







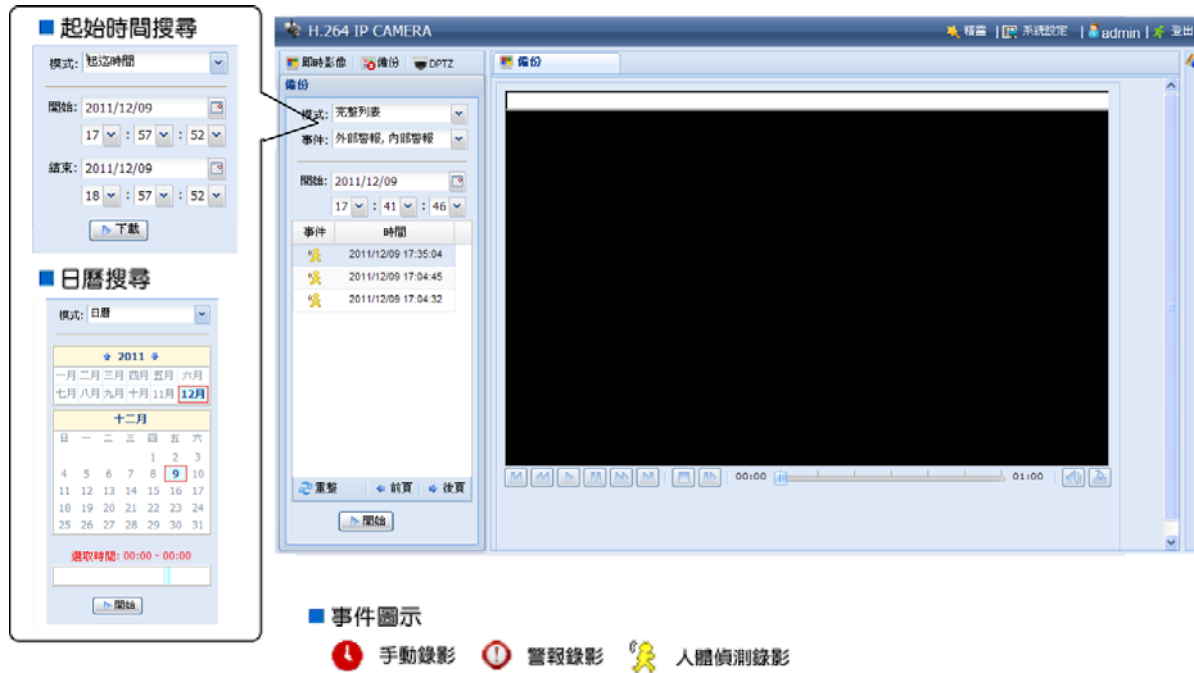

功能	圖示	說明
解析度	--	選擇 DPTZ 功能的影像解析度，包括 VGA 及 QVGA 選項。
快照		截取即時影像的畫面；影像檔會顯示於新視窗，按右鍵點選圖像，將圖像儲存在您指定的位置。
收音 開啓 / 關閉	 /	點選此按鈕切換開啓或關閉收音功能。
警報發出		強制警報裝置啓動。例如，若您連接了一台蜂鳴器，一旦按下此鈕，就算沒有發生警報，警鳴器也會放聲大響。

2.4 錄影事件搜尋與回放

此攝影機最多可以儲存三筆警報錄影事件。

註：若想要儲存更多錄影資料，建議可搭配相同的 NVR 使用。



	往前一小時 / 往後一小時	往前或往後一小時，例如 11:00 ~ 12:00 或 14:00 ~ 15:00，並開始播放在該時段最早的錄影資料。
	快轉	增加快轉的速度。點一次以 4 倍的速度快轉，兩次 8 倍，以此類推，最高速為 16 倍。
	倒轉	增加倒轉的速度。點一次以 4 倍的速度倒轉，兩次 8 倍，以此類推，最高速為 16 倍。
	播放	播放目前的錄影片段。
	暫停	暫停影片播放。
	停止	停止影片播放。
	單張播放	在暫停影片播放時，按一下格放前進一張影像。
	聲音	必要時，點一下關閉回放畫面內的錄音播放關閉，再點一下即可恢復。
	備份	將目前播放的錄影片段儲存在電腦的指定位置。 下載的影片只能使用我們專用的影片播放程式開啟。您可以從 [常用設定] → [系統維護] 下載此程式，或者從隨附的光碟裡取得。

3. 攝影機設定

使用者可以透過 Internet Explorer 登入攝影機進行更多設定。

3.1 系統設定選單

按 [系統設定] 進入設定頁面。

Note: You need to be "Supervisor" to enter the system configuration page. If you're not a "Supervisor", please re-log into the camera with the correct user name and password.

系統設定選項分成六個主要目錄選單：「網路設定」、「攝影機設定」、「定時錄影」、「儲存裝置」、「觸發設定」和「常用設定」。

- 如需得知「網路設定」的相關資訊，請參閱第 8 頁的「3.2 網路設定」。
- 如需得知「攝影機設定」的相關資訊，請參閱第 11 頁的「3.3 攝影機設定」。
- 如需得知「定時錄影」的相關資訊，請參閱第 11 頁的「3.4 定時錄影」。
- 如需得知「儲存裝置」的相關資訊，請參閱第 14 頁的「3.5 儲存裝置」。
- 如需得知「觸發設定」的相關資訊，請參閱第 15 頁的「3.6 觸發設定」。
- 如需得知「常用設定」的相關資訊，請參閱第 16 頁的「3.7 常用設定」。

主選單	子選單	說明
網路設定	網路設定	設定網路連線。
	頻寬控制	啟動頻寬限制。
	DDNS	若使用的網路類型為 PPPOE 或 DHCP，需輸入 DDNS 資訊。
	網路對時	將攝影機的時間和網路電腦系統同步化。
	影像上傳	若在 [觸發設定] → [觸發設定] 裡選擇 [FTP]，需在此輸入 FTP 資訊。
	郵件管理	若在 [觸發設定] → [觸發設定] 裡選擇 [E-Mail]，需在此輸入 E-Mail 資訊。
	過濾器	選擇要允許或封鎖能登入此攝影機的 IP 位址。
	UpnP	* 適用於 Windows 操作系統 允許在相同網域下的其他裝置能偵測得到這隻攝影機並可快速使用。
Bonjour	* 適用於 Mac 操作系統 Bonjour 是一項能夠在區網自動設定並偵測特定的網路服務。	
攝影機設定	攝影機設定	1. 設定攝影機名稱。 2. 變更攝影機名稱在螢幕上顯示的位置。
	影像設定	調整不同影像格式的相關影像設定。
	顏色設定	調整色彩效能。
	聲音	調整收音和擴音的音量。
	進階設定	調整攝影機參數。
定時錄影	錄影	設定錄影功能。
	定時錄影	預約人體偵測和外接警報錄影時間。
儲存裝置	SD 記憶卡	查看記憶卡容量，還可清除所有錄影資料。

主選單	子選單	說明
觸發設定	觸發設定	<ol style="list-style-type: none"> 1. 啟動 / 關閉 警報、位移、人體偵測功能。 2. 設定位移偵測範圍。 3. 設定攝影機在遇到各個事件時的回應。
常用設定	常用設定	<ol style="list-style-type: none"> 1. 選擇語言。 2. 查看攝影機的 MAC 位址。 3. 設定攝影機在指定時間過後自動上鎖禁止存取。 4. 開啓或關閉 LED 狀態指示燈。
	時間設定	設定日光節約時間和目前的時間。
	系統日誌	查看系統事件日誌。
	連線使用者	查看目前的線上使用者資訊。
	權限管理	<ol style="list-style-type: none"> 1. 建立具有不同存取權限的使用者帳號。 2. 修改或刪除現有使用者帳號。
	系統維護	<ol style="list-style-type: none"> 1. 查看目前的韌體版本與升級。 2. 複寫系統相關設定。 3. 重新啓動攝影機。 4. 下載影片播放器播放影片。

3.2 網路設定

3.2.1 網路設定

依您的網路類型而定，在此可設定攝影機的網路設定。

詳情請參閱「進階網路設定」，請由 www.surveillance-download.com/user/m301.swf 下載。

區域網路設定

IP類型: 固定IP PPPoE DHCP

IP位址: 60.250.165.98

閘道: 60.250.165.97

網路遮罩: 255.255.255.0

埠號: 80

DNS1: 168.95.1.1

DNS2: 139.175.55.244

MAC 位址: 00:0E:53:E5:EB:BE

儲存設定 重新載入

3.2.2 QoS

頻寬控制設定 (Quality of Service)，是一種控制機制，它提供了針對不同使用者或者不同資料流採用相應不同的優先順序，或者是根據應用程式的要求，保證資料流的效能達到一定的水準。勾選 [開啓]，設定最大上傳速率，設定範圍可從每秒 256 位元 到 10240 位元。

頻寬控制設定

頻寬控制: 開啓 關閉

介面: Ethernet

最大上傳速率: 4096 kbps

儲存設定 重新載入

3.2.3 DDNS

若在 [網路設定] 選取的網路類型為 [PPPOE] 或 [DHCP]，請選擇 [開啓]。

詳情請參閱「進階網路設定」，請由 www.surveillance-download.com/user/m301swf 下載。

DDNS設定

DDNS: 開啟 關閉

系統名稱: default

主機名稱: MAC000e5320d47c .ddns.eagleeyes.tw

E-Mail: manager@tech.com

3.2.4 網路對時

網路對時是用來同步化攝影機和網路電腦系統的時間。

網路對時設定

GMT: (GMT+08:00) Taipei

NTP伺服器: tock.stdtime.gov.tw

同步週期: 每天

主機時間: 2011-12-09 20:56:21

功能	說明
GMT	只要選好時區，網路攝影機就會自動調整系統的本機時間。
NTP 伺服器	您可以選擇保留預設的 SNTP 伺服器 (例如，tock.stdtime.gov.tw)，或者改成您知道的其他伺服器。
同步週期	選擇“每天”將每天的網路時間同步到攝影機，或選擇“無”來關閉此功能。
時間同步	按此按鈕後，網路攝影機的時間即會與網路時間同步。

3.2.5 影像上傳

輸入詳細的 FTP 資訊，然後按【儲存】確認。在【觸發設定】→【觸發設定】選取【FTP】時，則會套用設定於此的功能。

影像上傳設定

帳號: manager

密碼: ●●●●●●

主機名稱: 192.168.2.32

埠號: 21

路徑: upload

3.2.6 郵件管理

輸入詳細的電子郵件資訊，然後按【儲存】確認。在【觸發設定】→【觸發設定】選取【E-Mail】時，則會套用設定於此的功能。

SMTP設定

郵件主機名稱: ms.tech.com

埠號: 465

寄件人信箱: manager

SSL加密: 是 否

密碼驗證: 是 否

帳號: manager

密碼: ●●●●●●

收件人信箱清單

收件人信箱:

收件人	收件人信箱
boss	boss@tech.com

功能	說明
郵件主機名稱	輸入您從電子郵件系統供應商取得的 SMTP 伺服器位址。
埠號	輸入您從電子郵件系統供應商取得的埠號。若沒有填寫此欄，則會預設使用 25 做為傳送郵件的埠號。
寄件人信箱	輸入寄件人名稱。
SSL 加密	如果您是使用 SSL 加密協定來防止重要的資訊遭到攔截，請選擇“是”。
密碼驗證	有些郵件伺服器需要驗證密碼。請輸入【帳號】和【密碼】。
收件人信箱	新增指定收件人的電子郵件位址。
測試	當您輸入完所有資料，請點選“測試”來確認是否可以收到訊息。

3.2.7 過濾器

選擇要允許或封鎖能登入此攝影機的 IP 位址，然後按【儲存】確認。

功能	說明
■ 過濾器設定	
錯誤次數	設定登入失敗的最大可接收次數。登入失敗次數達到設定上限後，該 IP 位址就會被封鎖。
錯誤封鎖時間	設定被封鎖的 IP 位址，要被封鎖多久時間。
回應要求	選擇【不封鎖】讓其他使用者可以 ping 到此網路攝影機的 IP 位址，而選擇【封鎖】則可拒絕回覆 ping 指令。
■ IP/MAC 過濾設定	
IP/MAC 過濾	選擇要啟用或停用過濾器功能。
IP/MAC 過濾方法	若選擇【開啟】，請確認要允許或拒絕指定的 IP 位址。
■ IP/MAC 過濾條件	
條件	<ul style="list-style-type: none"> 若要新增 IP 位址，請在【條件】輸入 IP 位址，然後按【新增】。 若要刪除現有 IP 位址，先點選要刪除的位址，然後按【刪除】。

3.2.8 UPnP / Bonjour

UPnP 為 Universal Plug and Play (通用隨插即用) 的縮寫，即允許此裝置可以在家用與企業的網路環境中被偵測與使用，且可簡化安裝與設定流程，且只適用在 Windows 作業系統。

Bonjour 在功能面和 UPnP 完全一樣，不過 Bonjour 只適用在 Mac 作業系統。

➤ UPnP

➤ Bonjour

勾選 [開啓] 讓此攝影機可以在同網域下被偵測到，並將您的 [裝置名稱] 設定為好記的名稱。

啓用此功能後，其他與此攝影機位在相同網域下的電腦就可在 [網路上的芳鄰] 搜尋到此攝影機。

- 在 Windows 作業系統環境下，請將 [網路芳鄰] 和 [裝置名稱] 皆設定為好記的名稱。
- 在 Mac 作業系統環境下，請將 “” (finder) 或是 “Bookmark” 及 [裝置名稱] 皆設定為好記的名稱。

連接兩下找到的攝影機，即可快速開啓網路瀏覽器並進入登入頁面。

埠號轉址設定 (前提須支援 UPnP)

依此功能，您不需要額外進入 Router，也可設定埠號轉址。

詳情請參閱「進階網路設定」，請由 www.surveillance-download.com/user/m301.swf 下載。

註：在使用此功能之前，請先確認您的 Router 有支援 UPnP，而且此功能已開啓。如果沒有，您就還是要另外進入 Router 設定埠號轉址。

將 [埠號轉址] 設為 [開啓] 後，若沒有特別指定 [路由器 IP] 或 [HTTP 埠號]，系統就會自動偵測一組 IP 位址或指定一個埠號給您使用。



註：當設定成功時，您會在此頁面看到分配給此攝影機的 IP 位址和埠號。

3.3 攝影機設定

3.3.1 攝影機設定

重新命名攝影機裝置和變更裝置名稱在螢幕顯示位置於左上 / 右上 / 左下 / 右下。



3.3.2 影像設定

在不同影像格式下變更影像相關設定

- 畫質與畫面清晰度相關。
- FPS 表示影像的流暢度。FPS 的值越大，影像呈現越順暢。
- Max Bit Rate 表示在選定的影像格式和像素內，資料所能傳輸的最大限度。

影像設定

系統類型設定

電源頻率: 60 Hz

H264

解析度	品質	FPS	最大 Bit 速率
SXGA / HD720P	一般	30	5000
VGA	高	30	3000
QVGA	最好	30	3000
QQVGA	高	30	3000

MPEG4

解析度	品質	FPS	最大 Bit 速率
SXGA / HD720P	高	20	5000
VGA	高	30	3000
QVGA	高	30	3000
QQVGA	高	30	3000

JPEG

解析度	品質	FPS
SXGA / HD720P	高	30
VGA	高	30
QVGA	高	30
QQVGA	高	30

儲存設定 重新載入

3.3.3 顏色設定

調整色彩效能：亮度、對比度、色度和飽和度。按住滑桿做調整即可預覽色彩變更。

若要回復預設值，請按 [回到預設值]。

顏色設定

即時影像

亮度: 50
 對比度: 55
 色度: 50
 飽和度: 65



回到預設值 重新載入

3.3.4 聲音設定

拖曳滑桿來調整麥克風的音量。

音量設定

輸入(麥克風): 5 靜音

回到預設值 重新載入

3.3.5 進階設定

視需求調整攝影機相關參數。



項目	說明
快門速率	依您的需求設定快門速率。 選項有：1/10、1/30、1/15、1/6、1 和 2 秒。
鏡射	依您需求的架設環境，點選此功能後，畫面將水平旋轉。
翻轉	依您需求的架設環境，點選此功能後，畫面將旋轉 180 度。
消除雜音	依您需求的架設環境，按住並拖曳滑桿來選取在黑暗環境下的適當參數。等級從 0 ~ 10，級數越高，雜音越少。
白平衡	白平衡的設定是爲了表現出當時的色溫，並且讓原本白色的東西，在不同色溫下仍看到白色。 選項有：自動、白燈、冷光、日光、陰天及遮陽。
清晰度	藉由調整相機光圈大小及影像邊緣銳利化，可以讓影像的小細節看起來更清楚。 按住並拖曳滑桿來選取適當參數。等級從 0 ~ 100，級數越高，影像越清晰。

3.4 定時錄影

3.4.1 錄影

在 [定時錄影設定] 下：

- 啟動或停用所有錄影功能。將 [啟動] 設成 [否] 時，就會停用所有的錄影功能。
- 選擇是否要在儲存裝置容量滿時覆蓋之前的檔案繼續錄下去。
- 啟動或停用錄影收音功能。
- 選擇錄影影像解析度：SXGA / HD720P / VGA / QVGA

註：選擇越高的解析度，影片的畫質就會越好，但記憶體就會消耗的越快。



3.4.2 定時錄影

若要設定警報或人體偵測錄影，請選擇 [警報] 或 [人體偵測]，然後選擇要啟動錄影的時間。

註：警報功能請務必選擇開啓以使錄影功能正常進行。



3.5 儲存裝置

3.5.1 記憶體

在 [記憶體]，您可以查看可錄影的剩餘容量，還可選擇清除所有儲存在記憶體中的錄影資料。

註：已記錄的資料將會在您按重設鍵後及重新開啓攝影機時被移除。

此攝影機最多可以儲存三筆警報錄影事件。

註：若想要儲存更多錄影資料，建議可搭配相同的 NVR 使用。

註：欲知不同錄影解析度下能錄製的總預計時間，請參閱第 22 頁「附錄 2 傳輸速度參照表」。

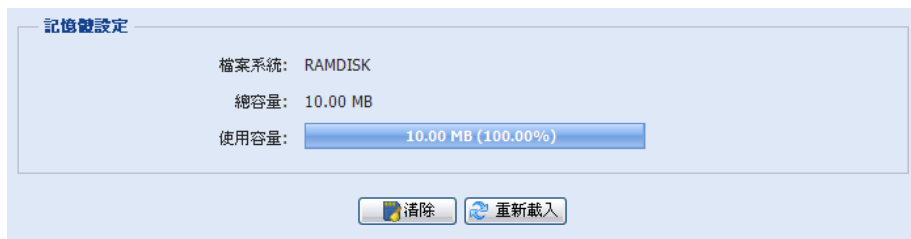

3.6 觸發設定

3.6.1 觸發設定

設定在發生警報或位移偵測後，攝影機的后續回應動作。

◆ 偵測

項目	說明
警報	視您連接的警報裝置而定，選擇 [N.O.] 或 [N.C.]。
移動	<p>開啓或關閉位移偵測功能。</p> <p>若將影像格式設為 [Motion JPEG]，就無法使用位移偵測功能。</p> <p>選取 [開啓] 後，按 [移動偵測] 進入移動偵測區域頁面如下：</p>  <p>靈敏度： 設定偵測靈敏度，從 1 到 10。</p> <p>區域設定： 使用電腦滑鼠設定移動偵測區域。粉紅色格子代表未被偵測的區域，而透明的格子代表有偵測的區域。您可以設定多個偵測區域。 按 [全部清除] 清除先前選擇的偵測區域，變成全部不偵測。 按 [全部選擇] 選取全區域進行偵測。</p>
人體偵測	開啓或關閉人體偵測功能。
警報持續時間	設定觸發時的錄影時間 (5 / 10 / 20 / 40 秒)。

◆ 動作

設定攝影機在發生事件時傳送通知給您的方式。

項目	說明
E-Mail	先選取要收到 E-Mail 通知的事件類型。 接著，按 [E-Mail] 字樣設定媒體類型 (H.264 / JPEG / MPEG4)，檔案格式 (AVC / AVI) 及事件錄影時間 (1 到 5 秒)。 當發生選取事件時，攝影機就會將錄好的影片傳送給在 [網路設定] → [郵件管理] 內指定的收件人。
FTP	先選取要收到 FTP 通知的事件類型。 接著，按 [FTP] 字樣設定媒體類型 (H.264 / JPEG / MPEG4)，檔案格式 (AVC / AVI) 及事件錄影時間 (1 到 5 秒)。 當發生選取事件時，攝影機就會將錄好的影片上傳到在 [網路設定] → [影像上傳] 內指定的位置。
警報發出	先選取要觸發警報裝置的事件類型。 接著，按 [警報發出] 字樣設定觸發規則。(低 / 高)
錄影	選取要啟動事件錄影的事件類型。

3.7 常用設定

3.7.1 常用設定

在 [常用設定] 裡，您可以選擇介面語言並查看攝影機的 MAC 位址。

若要讓 LED 狀態指示燈如第 2 頁的「1.6 狀態指示燈」所述顯示各個狀態，請在 [狀態 LED 使用模式] 選擇開啓；若要隱藏狀態，請選擇 [關閉]；若只要顯示錯誤狀態，請選擇 [暫時關閉]。

註：若重新啟動攝影機，狀態 LED 模式就會從[暫時關閉]回復為 [開啓]。

若要在閒置一段時間後鎖住攝影機登入，請在 [自動鎖定時間] 選擇 [5 分鐘]、[15 分鐘] 或 [30 分鐘]，或選擇 [從不鎖定] 關閉此功能。

註：要從攝影機鎖定的狀態下回復，請輸入登入時使用的密碼。



一般設定

一般設定

語言: 繁體中文

狀態LED使用模式: 開啟

自動鎖定時間: 15 分鐘

MAC 位址: 00:0E:53:E7:07:53

儲存設定 重新載入

3.7.2 時間設定

設定日光節約時間和目前的時間，然後按 [儲存] 確認。

時間設定

OSD: 開啓 關閉

日期: 2011/12/09

時間: 23 : 22 : 44

日光節約時間

日光節約時間: 開啓 關閉

開始時間: 八月 第一週 星期一 6 : 0 (HH:MM)

結束時間: 十月 第五週 星期一 10 : 0 (HH:MM)

調整時間: 1 : 0 (HH:MM)

功能	說明
■ 時間設定	
日期	設定今天的日期。
時間	設定現在的時間。
■ 日光節約時間設定	
日光節約時間	選擇是否要使用日光節約功能 (開啓 / 關閉)。
	若啓動了此功能，請設定 [開始時間] 和 [結束時間]，並調整日光節約時間，以小時為單位。

3.7.3 系統日誌

若要依事件類型來快速搜尋想要的系統日誌，按 [上一頁] 或 [下一頁]，或者勾選想要搜尋的事件類型，然後按 [重新查詢]。

若要清除所有系統日誌，請按 [清除全部日誌]。

系統日誌清單

編號	事件	時間	結果
1	遠端登入	2011/12/09 23:14:49	admin
2	遠端登入	2011/12/09 23:14:02	admin
3	遠端登入	2011/12/09 23:01:07	admin
4	遠端登入	2011/12/09 22:55:31	admin
5	遠端登入	2011/12/09 22:33:25	admin
6	遠端登入	2011/12/09 22:27:37	guest
7	遠端登入	2011/12/09 21:34:55	guest
8	遠端登入	2011/12/09 21:29:16	guest
9	遠端登入	2011/12/09 21:23:52	guest
10	遠端登入	2011/12/09 21:14:09	guest
11	遠端登入	2011/12/09 21:05:47	guest
12	遠端登入	2011/12/09 20:55:36	guest
13	遠端登入	2011/12/09 20:47:26	guest
14	遠端登入	2011/12/09 20:41:30	guest
15	遠端登入	2011/12/09 20:36:21	guest
16	遠端登入	2011/12/09 20:19:32	guest

3.7.4 連線使用者

您可以查看目前連線到此攝影機的使用者與其連線資訊。若要重新整理清單，請按 [重新查詢]。

- ▶ 若要允許匿名登入，請在 [影像匿名登入] 選擇 [開啓]。
- ▶ 若不要在登入時輸入影像驗證碼，請在 [Login with CAPTCHA Image] 選擇 [否]。

帳號	IP位址	權限	媒體類型
admin	61.63.7.65	系統管理者	H264
admin	61.63.7.65	系統管理者	H264

3.7.5 權限管理

您可以新增擁有不同使用者權限的帳號，或者刪除或修改現有帳號設定。

如何新增帳號

步驟 1：按 [New] (新增)，然後輸入以下欄位。

欄位	說明
帳號	設定要用來登入攝影機的帳號。帳號最多只允許 16 個由字母和數字組成的字元。
密碼	設定要用來進行遠端登入的密碼。密碼最多只允許 16 個由字母和數字組成的字元。
確認密碼	再輸入一次密碼確認。
權限	設定帳號的安全權限，以允許控制不同的功能。使用者權限共有四種：「系統使用者」、「超級使用者」、「一般使用者」和「訪客」。
登入時間	選擇此帳號可停留線上的時間：1 分鐘 / 5 分鐘 / 10 分鐘 / 1 小時 / 1 天 / 永久

步驟 2：接著，按一下 [儲存設定] 來儲存與完成帳號的建立。

如何修改或刪除現有帳號

步驟 1：選取想要修改或刪除的帳號。

步驟 2：若要修改帳號，請選擇 [修改] 變更設定，然後再按 [儲存設定]。若要刪除帳號，請按 [刪除]。

註：若帳號清單中只有一個帳號，則無法刪除該帳號。

3.7.6 系統維護

韌體更新

此功能可用來升級與更新攝影機功能。

註：在使用此功能之外，請確認已從安裝商或經銷商處取得升級檔案。

註：更新韌體將自動移除原先儲存於攝影機的事件影片。欲進行更新韌體前，請確認重要影像已經備份到您的電腦。

步驟 1：按  搜尋儲存更新檔的位置，然後選擇其中一個。(至多可選四個)



步驟 2：按 **[開始更新]** 即可開始系統升級。

註：建議保留目前的設定，否則更新後，所有設定都將回復到預設值

註：升級需要一些時間，請勿在這期間中斷電源，否則升級可能會失敗。升級完成後，攝影機將重新啓動。

系統組態備份

此功能是您將您的系統設定複製到 **System.bin** 的檔案裡。

您可以匯入相同的系統設定到另一台攝影機 (舉例：AVN801)，當 AVN801 重新被設為預設值時，您將可以選擇恢復為您原先的系統設定值。

在 **[韌體更新]** 選項裡，選擇 **System.bin** 檔案，並點選 **[開始備份]** 以匯入系統設定。

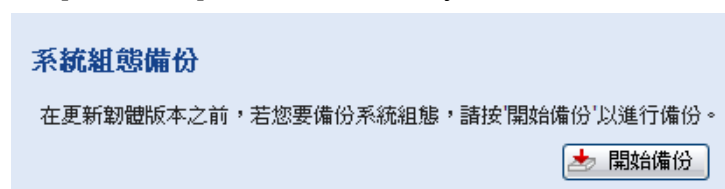

系統重新開機

若您需要重新啓動您的系統，請按下 **[重新開機]** 以進行系統重新啓動。

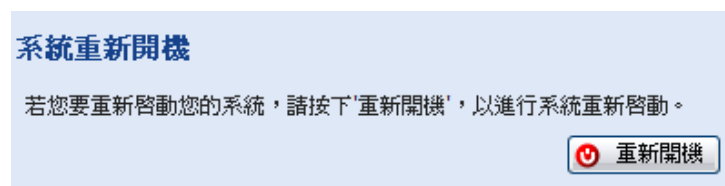

播放器下載

若您要播放下載之影像，請先下載並安裝播放器。

選擇 **[免費下載]** 以進行播放器下載，點選兩下即開始安裝。

播放器下載

若您要播放下載之影像，請先下載並安裝播放器。

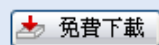

附錄 1 產品規格

■ 網路	
網路壓縮格式	H.264 / MPEG4 / MJPEG
多重影像傳輸 (Encode 模式、IPS、解析度)	3 (H.264, MJPEG, MPEG4)
LAN 埠	支援
LAN 速度	10/100 Based-T Ethernet
支援的協定	DDNS, PPPoE, DHCP, NTP, SNTP, TCP/IP, ICMP, SMTP, FTP, HTTP, RTP, RTSP, RTCP, IPv4, Bonjour, UPnP, DNS, UDP, IGMP, QoS
Frame 速率	NTSC:30, PAL:25
線上使用者人數	10
安全性設定	1. 多種使用者存取權限與密碼設定 2. 過濾 IP 位址 3. 摘要鑑別
遠端監控	1. 在 Windows 作業系統使用 Internet Explorer 2. iPhone、iPad 和 Android 行動裝置使用 EagleEyes 監控軟體
ONVIF 相容性	支援
■ 攝影機	
影像感測器	1/4" SONY 影像感測器
影像解析度	SXGA / HD720P / VGA / QVGA
最低照度	0.1 Lux / F1.5
信噪比	超過 48dB (AGC 關閉)
鏡頭	f3.8mm / F1.5
視角	62.7°
人體偵測感應器	在高度 2 米的情況下，最多可偵測長達 6 米寬 76° 的範圍 (溫度在 30°C 以下)
白平衡	ATW
AGC	Auto
IRIS 模式	AES
外接警報 I/O 埠	是
麥克風	是
電源 (±10%)	5V / 1A
操作溫度	0°C~40°C
■ 其他	
行動監控	iPad, iPhone & Android
RTC (網路對時)	是
移動偵測	是
數位 PTZ	是
事件通知方式	影像上傳 / 郵件傳送
網路瀏覽最低設備需求	<ul style="list-style-type: none"> • Pentium 4 CPU 1.3 GHz 或更高等級，或同級 AMD • 256 MB RAM • AGP 圖形顯示卡、Direct Draw、32MB RAM • Windows 7、Vista & XP，DirectX 9.0 或更新版本 • Internet Explorer 7.x 或更新版本

* 規格變動以實際產品為準，將不另行通知。

** 尺寸誤差範圍：± 5mm

附錄 2 傳輸速度參照表

以下資料僅供參考用。

下表所列的傳輸速度會因您實際選取的影像大小、影像品質和影像張數，以及監控畫面複雜度和物體移動頻繁度而有所差異。

測試環境

- 地點：辦公室入口
- 網路傳輸格式：H.264
- 攝影機類型：百萬畫素網路攝影機

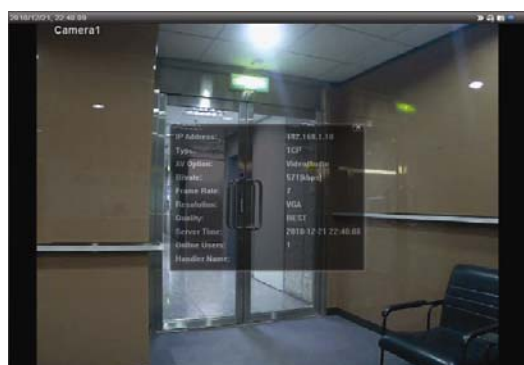

靜態畫面：無人出入



動態畫面：僅有一、兩人出入 (不頻繁)

影像規格	影像品質	Frame 速率	(動態畫面) kbps	(靜態畫面) kbps	
SXGA	最好	FULL	3253	3216	
	高		2375	2160	
	一般		1571	1266	
	基本		1465	873	
VGA	最好		2010	1261	
	高		1042	1034	
	一般		685	572	
	基本		457	350	
QVGA	最好		646	366	
	高		482	350	
	一般		302	286	
	基本		168	161	
SXGA	最好		1/4	1163	1076
	高			989	715
	一般			855	534
	基本			719	443
VGA	最好	789		571	
	高	451		447	
	一般	349		237	
	基本	217		165	
QVGA	最好	269		147	
	高	182		131	
	一般	164		113	
	基本	97		71	

影像規格	影像品質	Frame 速率	(動態畫面) kbps	(靜態畫面) kbps
SXGA	最好	1/15	581	374
	高		405	342
	一般		487	248
	基本		337	141
VGA	最好		358	79
	高		201	63
	一般		180	28
	基本		92	15
QVGA	最好		111	84
	高		99	68
	一般		97	54
	基本		58	42

附錄 3 常見問題集

如有更多關於 EagleEyes 的問題，請上官網 www.eagleeyesctv.com/supp_QnA.aspx。

問題	解答
當我在家中或是辦公室時，我可以成功連上攝影機，即使是沒有無線網路的情況下。但是一旦離開家裡或是辦公室，我卻無法從手機（連上 3G 網路）或是桌電（連上網路）進入攝影機，為什麼？	您尚未成功連上網際網路，您連上的網路為區域網路。請依說明書的指示完成網路設定，說明書下載請至 www.surveillance-download.com/user/m301.swf ；或是建議您與當地安裝商或當地供應商聯繫，協助安裝事宜。因為網路設定對於初次設定的人而言，難度較高。
影像看起來很不流暢。為什麼？	影像的流暢度會受到區域網路上傳頻寬、Router 的硬體效能、攝影機下載頻寬和畫面複雜度等因素有關。 ¹ (建議設定) 如需看到非常流暢的影像，解析度請選取 [QVGA]；如需看到最好的畫質呈現，解析度請選取 [SXVGA]；如對影像流暢度和畫面沒有特殊要求，建議解析度則選取 [VGA]。
何謂「推播通知」(Push Video)？	「推播通知」(Push Video) 是一種主動式事件通知系統，與一般常見的 FTP、Email 和 SMS 通知方式不同。 當偵測到人或外接警報器被觸發時，Push Video 系列智慧型攝影機會即時在 5 秒內傳送監控影像到您的手機，並啟動 EagleEyes 軟體，讓您立即觀看事件回放影片。
內建的人體偵測感應器，感應距離好像不遠，而且還會有感應不到的情形發生。為什麼？	此人體偵測感應器可能會受到周遭環境的溫度和人體溫度的影響而失判斷，其適用工作溫度應在 30°C 以內。若想要提升偵測的準確度和感應率，建議可外接其他警報裝置，例如：磁簧開關。 在安裝時有一些小訣竅，詳情請至 www.eagleeyesctv.com/supp_QnA.aspx 。
即時的影像畫面一直閃爍。為什麼？	您必須調整攝影機的電源頻率切換至 [60 Hz] 或 [50 Hz]。 iPhone 使用者，進入攝影機畫面，選擇即時畫面右上角的  進入 IPCAM 設定頁面，然後選擇 [進階設定] → [攝影機]，以變更設定。 Internet Explorer 瀏覽器使用者，登入攝影機後選擇 [系統設定] → [攝影機設定] → [攝影機設定]。